



NED UNIVERSITY OF ENGINEERING & TECHNOLOGY
PROCUREMENT CELL

Tele # 99261261- 68, (Ext. 2291) Fax # 99261255, E-mail: ddff@neduet.edu.pk

"Say NO to Corruption"

Director Procurement

No. PC/NED/109045/ 2535

Dated: 13-04-2017

Notice Inviting Tender

Sealed bids are invited from interested suppliers / firms / Distributors / Manufacturers for tenders mentioned below:-

S#	Number	Tender	Tender Schedule – Date and Time				Tender Fee Rs
			Issue / Sale		Submission	Opening	
			From	To			
1	DDSC/WORK/ DISMANTLING & FIXING OF M.S. GRILL/IMD/29/2017	Dismantling of Existing Parapet wall and Fixing M.S. Grill Hand Rail for Department of Industrial and Manufacturing / Mechanical Engineering	18-05-2017	03-05-2017	04-05-2017 10:30 A.M	04-05-2017 11:00 A.M	500/-

Bid Security @ 2.5% of the total bid cost PO / Bank Guarantee in favor of Director Finance

Tender Documents can be purchased from ADP-II office & shall be opened as per above schedule in same office.

2. Eligibility Criteria

- At-least 03 years experience in the relevant field
- Details of turn-over of at least last three years
- Registration with Federal Board of Revenue (FBR), for Income Tax and Sales Tax in case of procurement of goods
- Registration with the Sindh Revenue Board (SRB) in case of procurement of works and services
- An Affidavit on Stamp Paper that the firm has never been Blacklisted

3. Method of Procurement: (Single Stage One Envelope Procedure)

4. Terms & Conditions:

- Under following conditions bid will be rejected:-
 - Conditional and telegraphic bids/tenders
 - Bids not accompanied by Bid Security of required amount and form
 - Bids received after specified date and time
 - Bids of Blacklisted firms
- Bid Validity Period:** 90 days from the date of opening of Tender.
- Procuring Agency reserves the right to reject all or any bids subject to the relevant provisions of Sindh Public Procurement Rules-2010 (Amended 2013).and can divide business amongst more than on bidder.
- Tender document can be downloaded from SPPRA website www.pprasindh.gov.pk and this University website www.neduet.edu.pk further *detailed Terms & Conditions are mentioned in bidding documents*

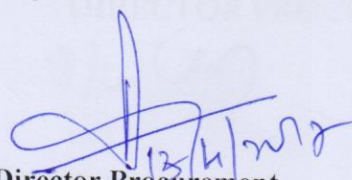
Director Procurement

o/c (2)

NED UNIVERSITY OF ENGINEERING & TECHNOLOGY

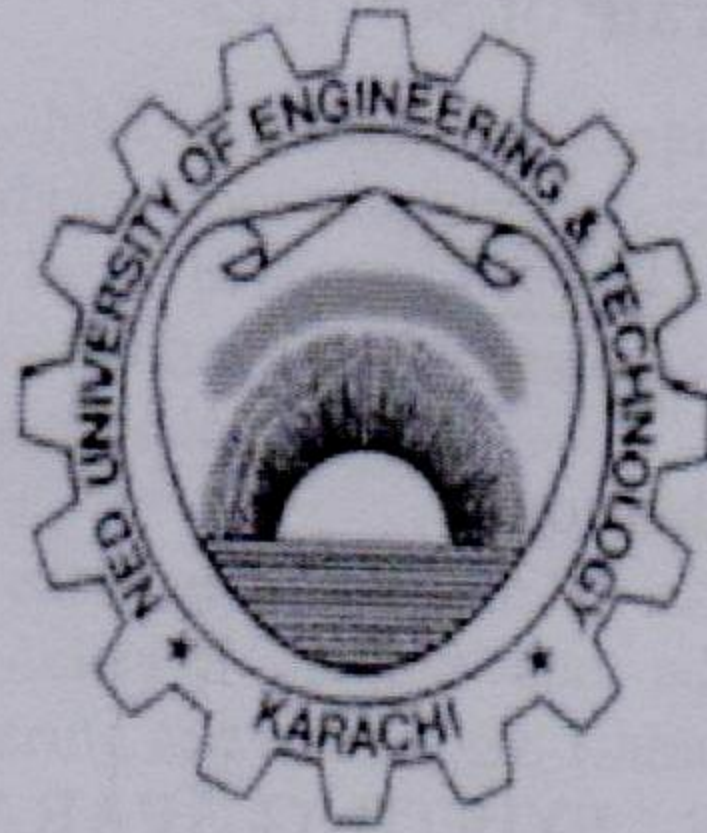

TENDER DOCUMENT

Directorate of Services

TITLE OF THE JOB

**DISMANTLING OF EXISTING PARAPET WALL AND FIXING
M.S GRILL HAND RAIL FOR DEPARTMENT OF
INDUSTRIAL AND MANUFACTURING /
MECHANICAL ENGINEERING DEPARTMENT**

DDS(C)/WORK/DISMANTLING & FIXING OF M.S GRILL/IMD/29/2017

NED UNIVERSITY OF ENGINEERING & TECHNOLOGY

Directorate of Services

To,

The Director Services
NED University of Engineering & Technology
Karachi

Subject: - DISMANTLING OF EXISTING PARAPET WALL AND
FIXING M.S GRILL HAND RAIL FOR DEPARTMENT OF
INDUSTRIAL AND MANUFACTURING / MECHANICAL
ENGINEERING DEPARTMENT

1. Having examined the instructions to the tenders, drawings, conditions of contract (General conditions and the conditions of particular application), and specifications, bill of quantities and having visited and inspected the site of the above named works. I/We the undersigned offer to carryout, complete the above works/supplies in conformity with the said instructions to tenders; conditions of work order/contract, specifications, Bill of Quantities, for the following sums or such other sum as may be ascertained in I accordance with said conditions.

Rs- _____ /- (Rupees _____)

2. We under take if my/our tender is accepted to commence the works within one week of recognized of the work order.
3. We agree to abide by this tender for a period of 90 days from the date of opening the same and it shall remain binding upon us and may be accepted at any time before the expiration of the said period of 90 days.
4. I/We understand that you are not bound to accept the lowest or any tender you may receive and you may reject any or all tenders without assigning any reason.

**Signature of Contractor/Seal of Firm
Authorised Representative of Firm**

INSTRUCTIONS TO TENDERS

- a) Director of Services, NED University of Engineering & Technology, calls tenders for the repair/constructions/replacement/supply in accordance with the Bill of Quantities attached here to be submitted by or before _____ AM on _____. Tenders cost will not be reimbursed for any cost of any kind whatsoever incurred in connection with the preparations and submission of their tenders.
- b) The tender for the each work should be in the sealed envelope bearing name of the work/contractor/firm clearly marked and addressed to Controller of Services, NED University of Engineering & Technology, Karachi.
- c) The tender may be delivered in person or sent by registered mail so as to reach on or before the date & time stated above. Any tender received after the stipulated time will not be considered regardless of the cause of delay.
- d) All tenders are invited to be present for the opening of the tender on _____ at _____ A.M. The name of each tenderer and his total contract price only will be read aloud and recorded.
- e) Any tender/tenders without earnest money will not be entertained. Earnest money of the awarding supplier may be return after successful delivery of the furniture. If the supplier fails to supply the quoted/awarded items within the stipulated time his/her work order will be cancelled as per rule and earnest money shall also be forfeited.
- f) Detailed particulars of the work/works can be seen in the Services Department on any working day during the office hours.
- g) Tenders shall be made in the forms supplied therefore, with all items and blanks properly filled in. All data and figures and the signature of persons signing the tender shall be in ink.

The completed forms should be without interlineations, alterations or erasures but if these are necessary to correct errors made by the tenderer, person(s) signing the tender shall initial them. Conditional tenders will not be accepted.
- h) All unit prices filled in the schedule of quantities shall be firm. The unit prices against each item of work and estimate amount and all other data called for shall be given.
- i) All prices quoted shall be deemed to include all costs of performing the works, including labour, materials, income tax, duties, octori charges, royalties permit etc. and no claim whatsoever shall be accepted in case of escalation any or all prices entered in rate of bid.

- j) The actual sum to be paid to the contractor whose tender is accepted shall be determined by measuring the work actually done or supplying/repairing the actual number of items in accordance with the work order and valuing it at the rates or prices by the contractor in the tender.
- k) "Incase of a discrepancy between the unit price and amount entered for any item in the schedule of quantities, the unit price will be taken as correct and the amount will be adjusted accordingly when the tender is being examined".
- l) 10% security deposit will be deducted from each bill on the paid amount of the contract, which will be returned after maintenance period of six months.
- m) The tender must be signed on each and every page by a person(s) authorized to do so.
- n) The samples can be seen on any working day during the office hours.
- o) "Engineer" means the Director Services of the University or any other Engineer appointed by him.

Director Services

APPENDIX TO FORM OF TENDER

2.5 % of the bid price payorder	
Period of commencement from receipt of letter of intent	Within One Week -----
Time completion	<i>Two Months</i> -----
Amount of liquidated damages	0.1 % of the contract amount per day for the work remains un-commenced and un-completed after due date upto maximum of 10% and after that termination of contract.
Period of maintenance	SIX MONTHS -----
Percentage of retention	10% from each running bill
Retention money retained during maintenance period	10% of Total work done amount
Minimum amount of Interim Certificate	50% -----
Contractor's address for serving the notice (Duly registered with concerned tax authorities)	-----
Persons or bodies corporate forming Partnership of Company	-----

**Signature of Contractor/Seal of Firm
Authorised Representative of Firm**

(BIDDING DATA)

(a). Name & Address of Procuring Agency	NED University of Engineering & Technology. Main University road, Karachi.
(b) Brief Description of Works	Dismantling of Existing Parapet wall and Fixing M.S Grill Hand Grill for Department of Industrial and Manufacturing / Mechanical Engineering Department.
(c) Amount of Bid Security	2.50% in shape of Payorder in favor of Director Finance NEDUET, Karachi.
(d). Period of Bid Validity (days)	90 days
(e). Time of Completion	Two Months
(f). Time of Maintenance	Six Months
(g). Period of commencement from receipt of letter of intent.	Within one Week
(h). Percentage of retention	10% from each running bill
(i). Performance Bond	10%
(j). Retention money retained during maintenance Period.	10% of Total work done amount
(k). Minimum amount of Interim Certificate	50%
(l). Deadline for Submission of Bids along with time.	
(m). Liquidity damages:	(0.1% of the contract amount per day for the remains un-commenced and un-completed after due date maximum of 10% and after than termination of contract
(n). Eligibility	<ul style="list-style-type: none"> - Registration with FBR for Income Tax, Sales Tax in case of procurement of goods, registration with the Sindh Revenue Board in case of Procurement of Works and Services and registration with Pakistan Engineering Council as the case may and are not black listed in any procuring agency or authority. - At least three years relevant experience - At least three years turnover details

Director Procurement

NED UNIVERSITY OF ENGINEERING & TECHNOLOGY
Directorate of Services

Terms & Condition

1. The work/supply is required within 90 days from the date of letter of award.
2. Inspection: *Nominated Inspection Committee will make Inspection of work by CID/DS/DDS(C)/ADS(C)/*
3. In case of late delivery @ 0.1% per day will be charged on bid amount deducted from the bill, but not more than 10% of contract value.
4. Quantities shown in the quotation are approximate and no claim shall be entertained for quantities of executed being 30% more or less than those entered in the B.O.Q.
5. All prices will include all costs of performing the works including labour, material, income tax, GST, octroi charges, royalties & transportation etc. as mentioned in B.O.Q.
6. No subletting of all or any part of work will be allowed at any cost / reasons.
7. The supplier will see the site/sample before quoting the rates.
8. Store will be delivered at NED University, Main Campus.
9. Central Stores and Inspection Officer will issue inspection certificate after inspection through Inspection Committee. **N/A**
10. If the work/supply is not found according to the specification and samples provided, will be rejected at risk and cost of the manufacturer and in case the manufacturer fails to work/supply the order, the firm will be black listed.
11. Payments: -
 - 11.1 The actual sum to be paid shall be determined by quantifying/measurements of items actually supplied valuing it at the rates/prices quoted in the approved quotations.
 - 11.2 10% security deposit will be retained from each bill up to a period of six months from the date of supply of order.
 - 11.3 Part payment against part supply can be allowed.

Director Services

Subject: BOQ FOR DISMANTLING OF EXISTING PARAPET WALL AND FIXING M.S GRILL HAND RAIL FOR DEPARTMENT OF INDUSTRIAL AND MANUFACTURING / MECHANICAL ENGINEERING DEPARTMENT

Sr. No.	Description of Items	Unit	Qty.	Rate (Rs.)	Total (Rs.)
01	Dismantling of existing C.C Parapet wall, screed very carefully in any height and thickness in any floor without damaging roof surface and tack out unserviceable material outside the University limit.	Sft	1400		
02	Providing & laying fair face cement concrete 1:2:4 Toe wall using approved 3/4" maximum size graded crushed leveling compacting and curing etc. including cost of fair face formwork. Complete and as per drawing and as per directed by the Engineer.	Cft	400		
03	Providing and fixing M.S grill handrail of approved designed and pattern shown in drawing comprising 1"x3/8" M.S flat frame top & bottom 1/2" x 1/2" M.S square bars in vertical direction at spacing 10"CC including cost of M.S hollow pipe 2 1/2" D-type 12swg welding etc. and painting 03 coats with approved enamel paint ICI brand over a coat of red-oxide etc. complete as per drawing and directed by the Engineer.	Sft	680		
TOTAL AMOUNT					

Signature of Contractor with Seal

Handwritten signature and date: 21/02/17

DIRECTORATE OF SERVICES
NED UNIVERSITY OF ENGINEERING & TECHNOLOGY

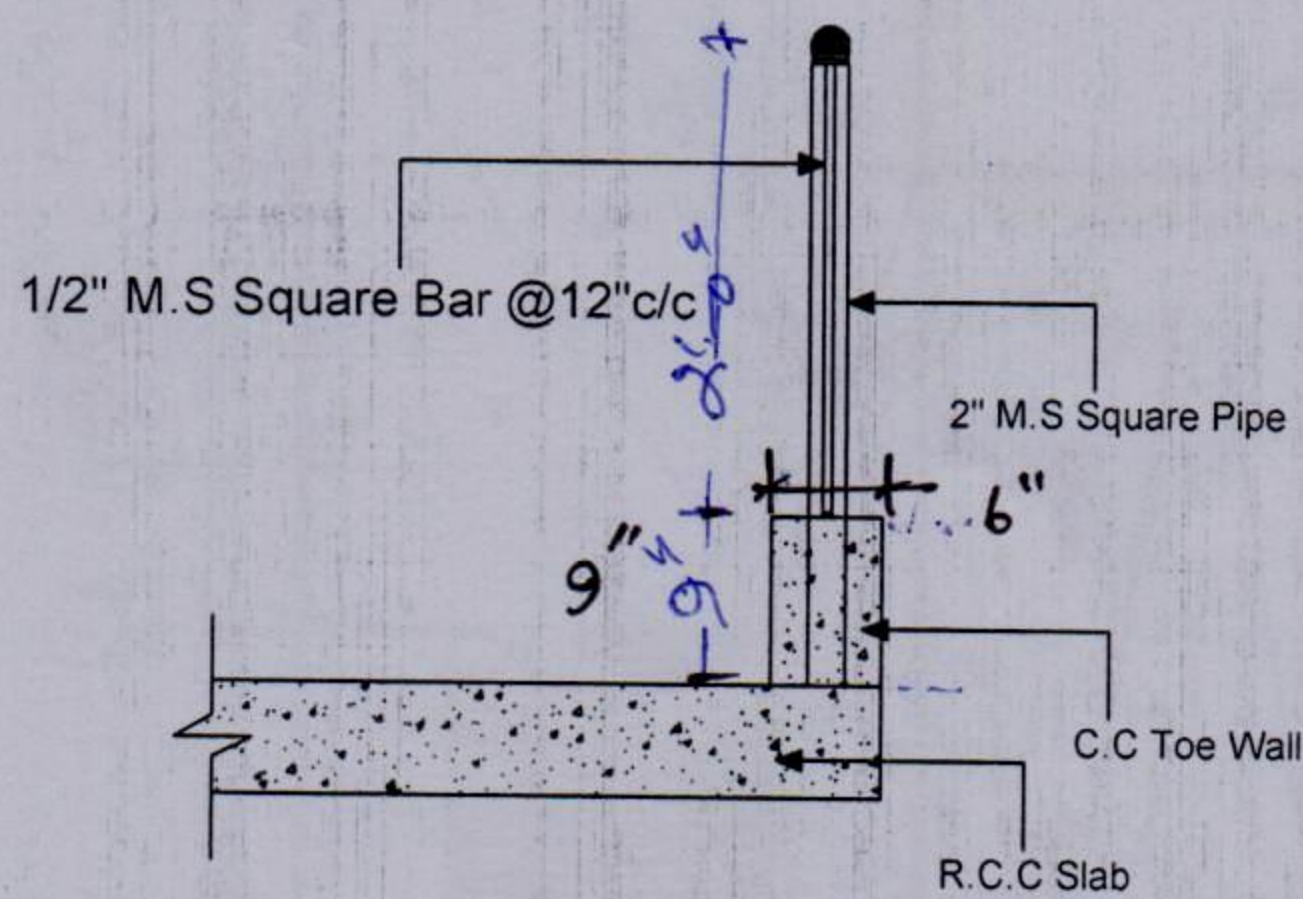
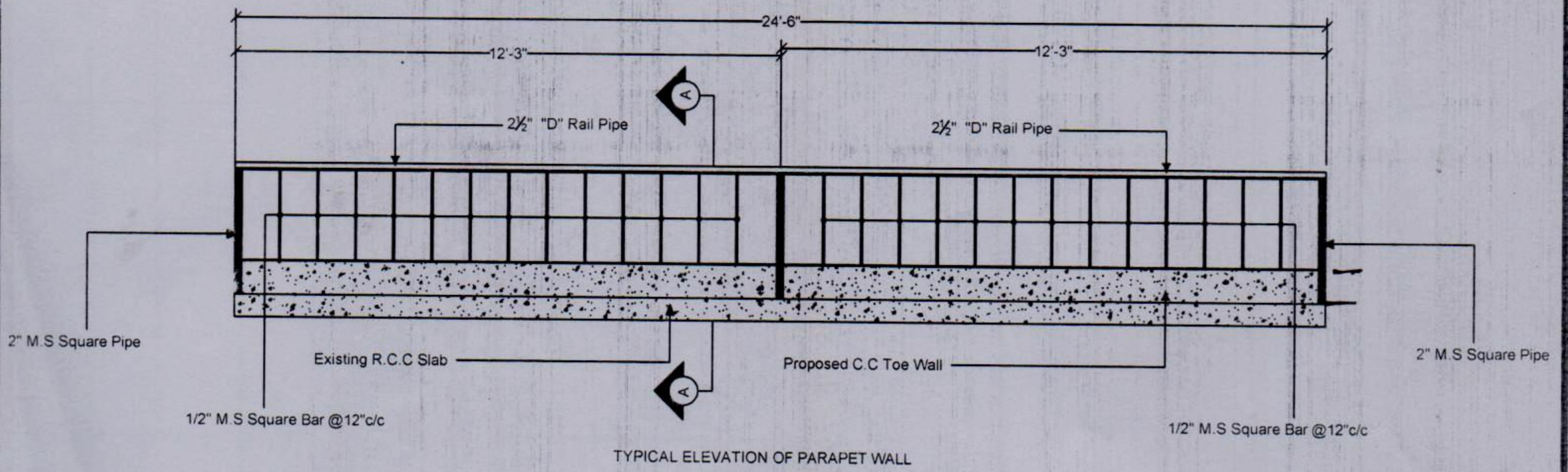

SECTION A-A

Handwritten notes:
 DRG NO
 21/02/17

DRG.NO 01

TITLE

TYPICAL ELEVATION & SECTION
 FOR
 PROPOSED PARAPET WALL AT IMD

DRAWN BY	CHECKED BY
APPROVED BY	SCALE
	N.T.S

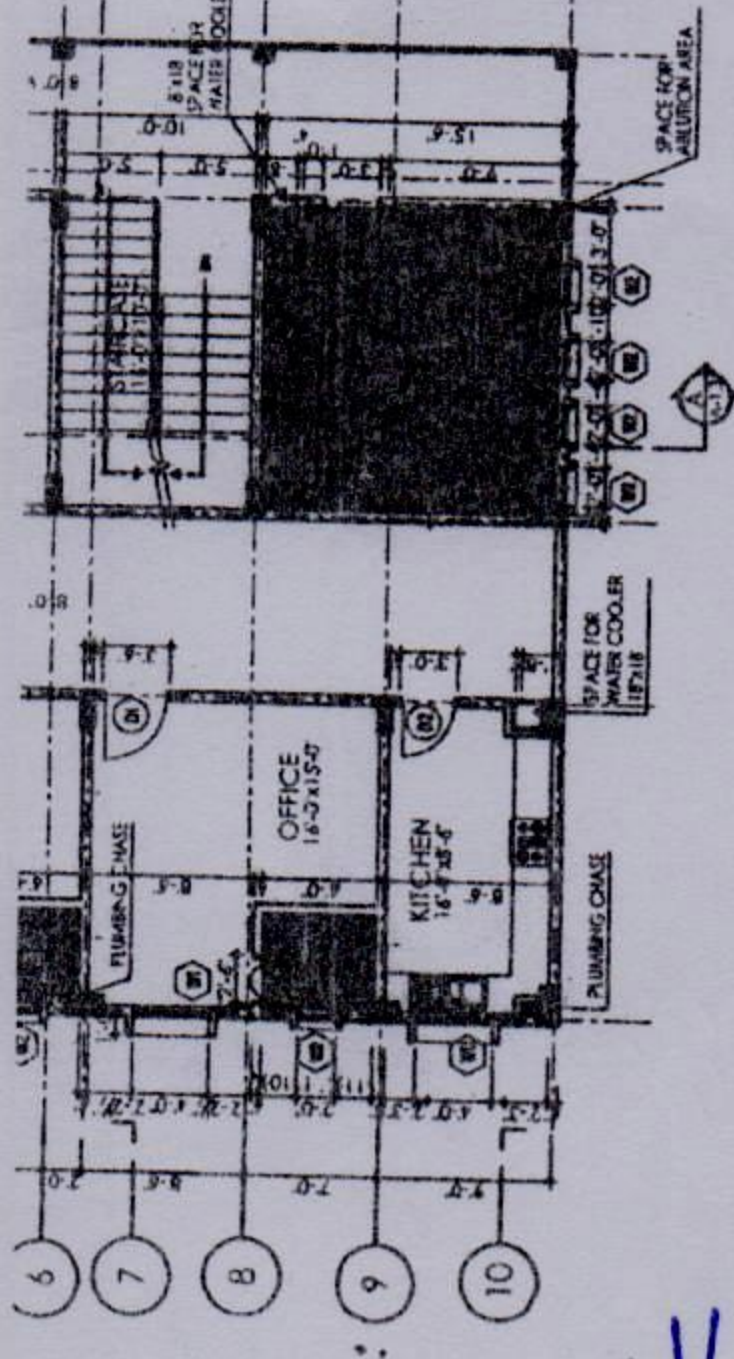

SECOND FLOOR PLAN

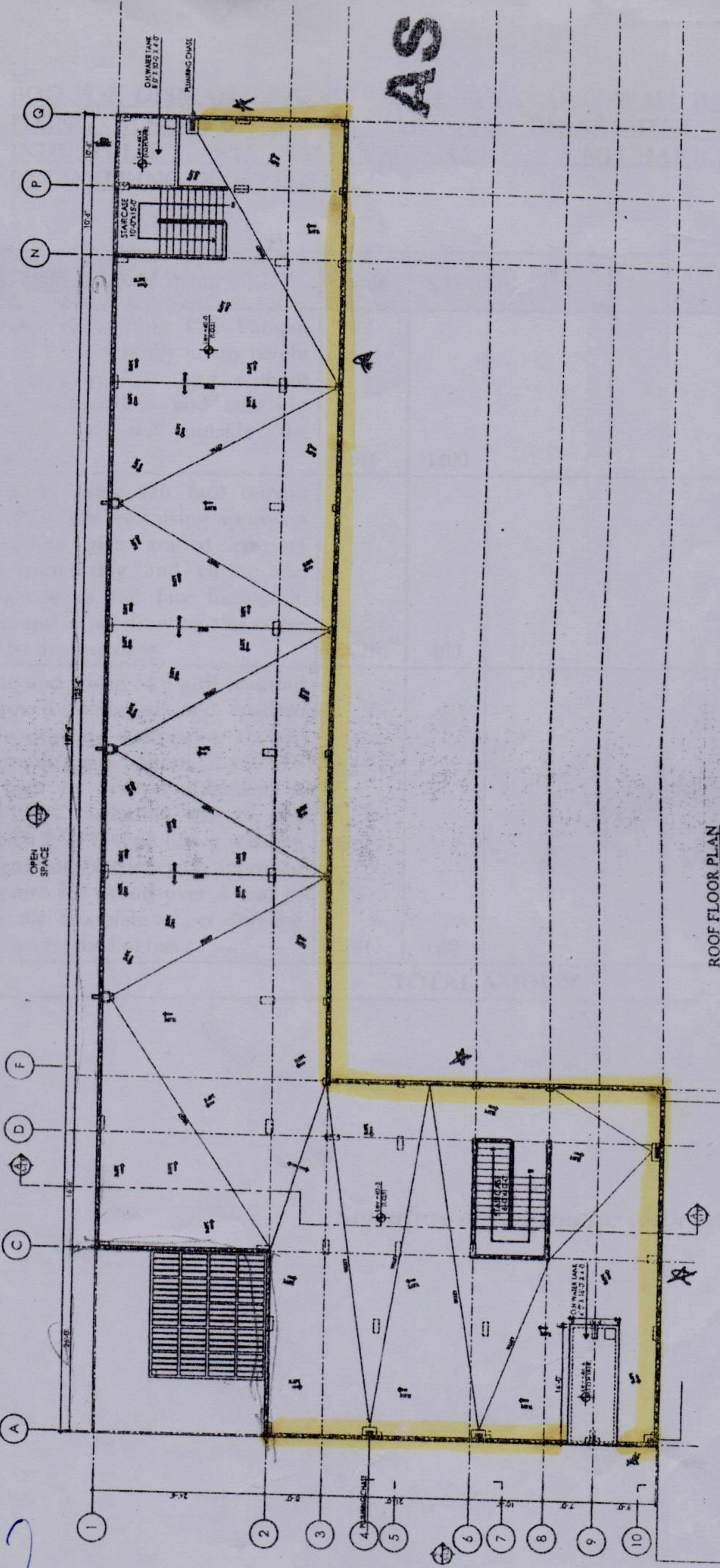

ROOF FLOOR PLAN

Handwritten signature and date:
 AS (Signature)
 21/02/17

General Notes:

- The contractor shall check & verify all dimensions before starting work, & report all errors & omissions to the Engineer immediately.
- The drawing shall not be used for construction purposes until signed by the consultant and issued for construction.
- Do not scale the drawing.

NOTE:

- ALL DIMENSIONS TO BE RECONFIRMED ON SITE
- ALL WORKS APPROVED

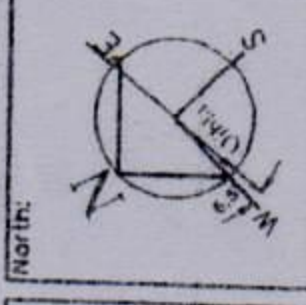

BE THE ARCHITECT™

Project: NED UNIVERSITY OF ENGINEERING AND TECHNOLOGY, KARACHI (ADDITION & ALTERATION)

Architects: THE ARCHITECTS
 architecture planning interiors
 12A Hasnain Homes Block 5 Clifton Karachi
 Phone No. 3520028-9, 3568506, Fax: 3570129

Title: SECOND & ROOF FLOOR (WORKING PLAN)
 (CONSTRUCTION OF INDUSTRIAL MANUFACTURAL ENGINEERING DEPARTMENT)