



Dated the 24-11, 2016

NOTICE INVITING TENDERS

Sealed Tenders (Single Stage two Envelopes) are invited as per SPPRA Rules on SBD from the Interested Persons/ Firms/Contractors who wish to participate in the tenders for bidding of the following works under ADP 2016-17

S.#	Name of scheme	Tender Fee (Rs.)	Period
1	Installation of Solar Lights in Rural Sindh Shaheed Benazirabad Division	3000	30-06-2017

PROGRAMME FOR ISSUE / RECEIPT AND OPENING OF TENDERS

S.#	Particulars	1st Attempt	In case of un-responded works
			2nd Attempt
1	Last date of receipt of application for issuance of Blank Tenders from publication of NIT upto 5:00 PM	15-12-2016	30-12-2016
2	Date of receipt of Tenders and opening (Receipt of tenders upto 11.00 am & opening at 12.00 Noon)	16-12-2016	31-12-2016

TERMS AND CONDITIONS OF THE TENDERS

- Contract documents and other terms and conditions can be seen and blank tenders can be obtained from the office of the undersigned on any working day during working hours after publication of advertisement upto the dates mentioned above on payment documents charges (Non-refundable)
- 2% of the total bid amount as Earnest Money is to be submitted along with tender document in shape of Call Deposit of any reputed Bank of Pakistan, in the name of undersigned.
- No conditional tenders will be entertained.
- The tenders will be opened at 12.00 noon in presence of the Procurement Committee and Contractors/Firms or their authorized agents who are present in the office of Director General RDD situated at Old SRTC Building Old Wahadat colony Hyderabad at the time, other terms and condition, specifications, drawing & design can be seen in the office of the undersigned on any working day during working hours.
- If the undersigned happens to be out of the Headquarter on the date of opening of tenders or in case of holiday or any disturbance the same will be opened on the next working day in presence of interested bidders or their authorized agents as per schedule.
- The procuring agency may reject any or all bids or proposal at any time prior to the acceptance of a bid or proposal under SPPRA Rule-25(1) 2010 (Amended 2013).
- Registration with Income Tax Department (NTN Certificate) and copy of CNIC.
- Registered with Sales Tax.
- Registration with SRB.
- Duly licensed by the Pakistan Engineering Council (PEC) minimum Category C-2 with codes CE01, CE09, CE10, EE06 and EE11.
- Financial Statement(s) for last 2 years duly issued by the recognized bank which must be upto Rs.300.0 million Turn-over.
- Company Profile.
- List of works of similar nature and size completed or in hand for last 3 years.
- Undertaking on Affidavit the firm is not involved in any litigation or abandoned any work in the any Department.
- Affidavit to the effect that the Firm/Contractor have not been black listed previously by any executing agency.
- Affidavit to effect that all documents/particulars/information furnished are true & correct.
- The bids should be properly signed and stamped (each & every paper) as per SPPRA rule otherwise bid will be rejected.
- In case of firm, list of Partners/Partnerships Deed, giving full particulars of Directors/Proprietors or other connected alongwith Power of Attorney. In case of being sole proprietors such undertaking on Affidavit be furnished.

EXECUTIVE ENGINEER
RURAL DEVELOPMENT DEPARTMENT
SHAHEED BENAZIRABAD

Copy to:-

- The Secretary, PHE & Rural Development Department, Govt. of Sindh, Karachi for information.
- The Director General, NAB Sindh, Karachi for information
- The Director General, Rural Development Department Sindh, Hyderabad for information.
- The Director (Technical) Rural Development Deptt: Sindh Hyderabad for information.
- Copy alongwith seven (7) spare copies of N.I.T. f.w.cs to the Director of Information (Advertisement) Information Department Govt. of Sindh Karachi for information & publication in leading daily News Papers as per SPPRA Rules.
- Copy of N.I.T. alongwith soft copy f.w.cs to the Director Sindh Public Procurement Regulatory Authority, Barrack No.8, Sindh Secretariat No.4-A, Karachi for information and publication (Up-load) on website www.pprasindh.gov.pk.
- Copy on Notice Board (Local)

EXECUTIVE ENGINEER
RURAL DEVELOPMENT DEPARTMENT
SHAHEED BENAZIRABAD

3316
28-11-16

GOVERNMENT OF SINDH
RURAL DEVELOPMENT DEPARTMENT



BIDDING DOCUMENT
FOR
INSTALLATION OF SOLAR LIGHTS IN RURAL SINDH
SHAHEED BENAZIRABAD DIVISION

Issued to:-

Date of Issue:-

D.R No. & Date:-

Amount Rs.

EXECUTIVE ENGINEER
RURAL DEVELOPMENT DEPARTMENT
SHAHEED BENAZIRABAD

INVITATION FOR BIDS

**INSTRUCTIONS
TO
BIDDERS**

INSTRUCTIONS TO BIDDERS

(Note: These Instructions to Bidders along with bidding data will not be part of the Contract and will cease to have effect once the contract is signed.)

A. GENERAL

IB.1 Scope of Bid

- 1.1 Procuring agency as defined in the bidding data hereinafter called "the procuring agency" wishes to receive bids for the construction and completion of works as described in these bidding documents, and summarized in the bidding data hereinafter referred to as the "Works".
- 1.2 The successful bidder will be expected to complete the works within the time specified in Appendix-A to Bid.

IB.2 Source of Funds

- 2.1 RURAL DEVELOPMENT DEPARTMENT, GOVERNMENT OF SINDH

IB.3 Eligible Bidders

- 3.1 Bidding is open to all firms and persons meeting the following requirement:
 - a. Duly licensed by the Pakistan Engineering Council (PEC) minimum Category C-2 with codes CE01, CE09, CE10, EE06 and EE11.
 - b. Bidder Shall provide following documents with bidding documents
 - (i) Company profile
 - (ii) Previous experience of works of similar nature and size performed in last 3 years.
 - (iii) Qualification and experience of technical personnel and key site management.
 - (iv) Financial Statement of last 3 years.
 - (v) Information regarding litigations and abandoned works if any.
 - (vi) Registration with Income Tax, Sales Tax and other relevant authorities.

IB.4 One Bid per Bidder

IB.5 Cost of Bidding

- 5.1 The bidders shall bear all costs associated with the preparation and submission of their respective bids, and the procuring agency will in no case be responsible or liable for those costs, regardless of the conduct or outcome of the bidding process.

IB.6 Site Visit

- 6.1 The bidders are advised to visit and examine the site of works and its surroundings and obtain all information that may be necessary for preparing the bid and entering into a contract for construction of the works. All cost in this respect shall be at the bidder's own expense.
- 6.2 The bidders and any of their personnel or agents will be granted permission by the procuring agency to enter upon his premises and lands for the purpose of such

inspection, but only upon the express condition that the bidders, their personnel and agents, will release and indemnify the procuring agency, his personnel and agents from and against all liability in respect thereof and will be responsible for death or personal injury, loss of or damage to property and any other loss, damage, costs and expenses incurred as a result of such inspection.

B. BIDDING DOCUMENTS

IB.7 Contents of Bidding Documents (SSP RULE 21)

- 7.1 The bidding documents, in addition to invitation for bids, are those stated below and should be read in conjunction with any addenda issued in accordance with Clause IB.9.
- a. Instructions to Bidders.
 - b. Bidding Data.
 - c. General Conditions of Contract, Part-I (GCC).
 - d. Form of Bid and Schedule to Bid.
 - e. Form of Bid Security.
 - f. Form of Contract Agreement.
 - g. Forms of Performance Security, Mobilization Advance Guarantee, Integrity Pact and Indenture bond for secured advance.
 - h. Bill of Quantity and Drawings.

- 7.2 The bidders are expected to examine carefully the contents of all the above documents. Failure to comply with the requirements of bid submission will be at the bidder's own risk. Pursuant to Clause IB.26, bids which are not substantially responsive to the requirements of the BD will be rejected.

IB.8 Clarification of Bidding Documents (SSP RULE 23(1)):

Any interested bidder requiring any clarification(s) in respect of the bidding documents may notify the procuring agency in writing at the procuring agency's address indicated in the Invitation for Bids/NIT. Procuring agency will respond to any request for clarification provided they are received at least five calendar days prior to the date of opening of bid.

Provided that any clarification in response to query by any bidder: shall be communicated to all parties who have obtained bidding documents.

IB.9 Addendum/Modification of Bidding Documents:

- 9.1 At any time prior to the deadline for submission of bids, the procuring agency may, for any reason, whether at his own initiative or in response to a clarification requested by a interested bidder, modify the bidding documents by issuing addendum.
- 9.2 Any addendum thus issued shall be part of the bidding documents pursuant to sub-clause IB 7.1 hereof and shall be communicated in writing to all bidders. Interested bidders shall acknowledge receipt of each addendum in writing to the procuring agency.
- 9.3 To afford bidders reasonable time in which to take an addendum into account in preparing their bids, the procuring agency may extend the deadline for submission of bids in accordance with IB.20

C. PREPARATION OF BIDS

IB.10 Language of Bid

- 10.1 The bid and all correspondence and documents related to the bid exchanged by a bidder and the procuring agency shall be in the English language stipulated in the bidding data and Special Conditions of the Contract. Supporting documents and printed literature furnished by the bidders may be in any other language provided the same are accompanied by an accurate translation of the relevant parts in the bid language, in which case, for purposes of evaluation of the bid, the translation in bid language shall prevail.

IB.11 Documents Accompanying the Bid

- 11.1 Each bidder shall:
- (a) submit a written authorization on the letterhead of the bidding firm, authorizing the signatory of the bid to act for and on behalf of the bidder;
 - (b) update the information indicated and listed in the bidding data and previously submitted with the application for prequalification, and continue to meet the minimum criteria set out in the prequalification documents
- 11.2 Bids submitted by a joint venture of two (2) or more firms shall comply with the following requirements:
- (a) one of the joint venture partners shall be nominated as being in charge
 - (b) the bid, and in case of a successful bid, the Form of Contract Agreement shall be signed by the authorized/lead partner so as to be legally binding on all partners;
 - (c) the partner-in-charge shall always be duly authorized to deal with the procuring agency regarding all matters related with and/or incidental to the execution of works as per the terms and Conditions of Contract and in this regard to incur any and all liabilities, receive instructions, give binding undertakings and receive payments on behalf of the joint venture;
- 11.3 Bidders shall also submit proposals of work methods and schedule, in sufficient detail to demonstrate the adequacy of the bidders' proposals to meet the technical specifications and the completion time referred to sub-clause IB 1.2 hereof.

IB.12 Bid Prices

- 12.1 Unless stated otherwise in the bidding documents, the contract shall be for the whole of the works as described in IB 1.1 hereof, based on the unit rates or prices submitted by the bidder or percentage quoted above or below on the rates of Composite Schedule of Rates (CSR), as the case may be.
- 12.2 The bidders shall fill in rates and prices for all items of the works described in the Bill of Quantities. Items against which no rate or price is entered by a bidder will not be paid for by the procuring agency when executed and shall be deemed to be covered by rates and prices for other items in the Bill of Quantities. In case of Composite Schedule of Rates, if the bidder fails to mention the percentage above or below, it

shall be deemed to be at par with the rates of Composite Schedule of Rates.

- 12.3 The bid price submitted by the contractor shall include all rates and prices including the taxes as of date of tender. All duties, taxes and other levies payable by the contractor under the contract, or for any other cause during the currency of the execution of the work or otherwise specified in the contract as on the date seven days prior to the deadline for submission of bids.

If, after the date of this contract, there is any change in the applicable law with respect to taxes and duties which increases or decrease the cost incurred by the contractor in performing the services, then the remuneration and reimbursable expenses otherwise payable to contractor under this contract shall be increased or decreased accordingly by agreement between the parties, and corresponding adjustments shall be made to the amounts.

Additional / reduced duties, taxes and levies due to subsequent additions or changes in legislation shall be reimbursed / deducted as per Sub-Clause 13.7 of the General Conditions of Contract Part-I.

- 12.4 The rates and prices quoted by the bidders are subject to adjustment during the performance of the contract in accordance with the provisions of Clause 13.7 of GCC. The bidders shall furnish the prescribed information for the price adjustment formulae in Appendix-C to Bid, and shall submit with their bids such other supporting information as required under the said Clause. Adjustment in prices quoted by bidders shall be allowed as per Sub-Para 4(ii) of Section C of Instructions to bidders and bidding data.

IB.13 Currencies of Bid and Payment

- 13.1 The unit rates and the prices shall be quoted by the bidder entirely in Pak rupees. A bidder expecting to incur expenditures in other currencies for inputs to the works supplied from outside the procuring agency's country (referred to as the "Foreign Currency Requirements") shall indicate the same in Appendix-B to Bid. The proportion of the bid price (excluding Provisional Sums) needed by him for the payment of such Foreign Currency Requirements either (i) entirely in the currency of the bidder's home country or, (ii) at the bidder's option, entirely in Pak rupees provided always that a bidder expecting to incur expenditures in a currency or currencies other than those stated in (i) and (ii) above for a portion of the foreign currency requirements, and wishing to be paid accordingly, shall indicate the respective portions in the bid.
- 13.2 The rates of exchange to be used by the bidder for currency conversion shall be the selling rates published and authorized by the State Bank of Pakistan prevailing on the date, 07 (seven) days prior to the deadline for submission of bids. For the purpose of payments, the exchange rates used in bid preparation shall apply for the duration of the contract.

IB.14 Bid Validity

- 14.1 Bids shall remain valid for the period stipulated in the bidding data from the date of opening of bid specified in clause IB.23.
- 14.2 In exceptional circumstances, prior to expiry of the original, the procuring agency may request the bidders to extend the period of validity for a specified additional

period, which shall not be for more than one third of the original period of bid validity. The request and the responses thereto, shall be made in writing. A bidder may refuse the request without the forfeiture of the bid security. In case, a bidder agreed to the request, shall not be required or permitted to modify the bid, but will be required to extend the validity of the bid security for the period of the extension, and in compliance with Clause IB.15 in all respects.

IB.15 Bid Security

- 15.1 Each bidder shall furnish, as part of the bid, a bid security in the amount stipulated in the bidding data in Pak Rupees or an equivalent amount in a freely convertible currency.
- 15.2 The bid security shall be at the option of the bidder, in the form of deposit at call. Pay order or a bank guarantee issued by a Scheduled Bank in Pakistan or from a foreign bank duly counter guaranteed by a Scheduled Bank in Pakistan in favour of the procuring agency, which should commensurate with the bid validity period. The bank guarantee for bid security shall be acceptable in the manner as provided at Annexure BS-1
- 15.3 Any bid not accompanied by an acceptable bid security shall be rejected by the procuring agency as non-responsive.
- 15.4 Bid security shall be released to the unsuccessful bidders once the contract has been signed with the successful bidder or the validity period has expired.
- 15.5 The bid security of the successful bidder shall be returned when the bidder has furnished the required Performance Security and signed the Contract Agreement.
- 15.6 The bid security may be forfeited:
 - (a) if the bidder withdraws his bid except as provided in sub- clause IB 22.1;
 - (b) if the bidder does not accept the correction of his bid price pursuant to sub-clause IB 27.2 hereof; or
 - (c) In the case of successful bidder, if he fails within the specified time limit to:
 - (i) furnish the required Performance Security; or
 - (ii) sign the Contract Agreement.

IB.16 Alternate Proposals/Bids

- 16.1 Each bidder shall submit only one bid either by himself, or as a member of a joint venture, until and unless they have been requested or permitted for alternative bid, then he has to purchase separate bidding documents and alternate bid shall be treated as separate bid.
- 16.2 Alternate proposals are not allowed

IB.17 Pre-Bid Meeting

- 17.1 Procuring agency may, on his own motion or at the request of any bidder, hold a pre-

bid meeting to clarify issues and to answer any questions on matters related to the bidding documents. The date, time and venue of pre-bid meeting, if convened, shall be communicated to all bidders. All bidders or their authorized representatives shall be invited to attend such a pre-bid meeting at their own expense.

- 17.2 The bidders are requested to submit questions, if any, in writing so as to reach the Procuring agency not later than seven (7) days before the proposed pre-bid meeting.
- 17.3 Minutes of the pre-bid meeting, including the text of the questions raised and the replies given, will be transmitted without delay to all bidders. Any modification of the bidding documents listed in sub- clause IB 7.1 hereof, which may become necessary as a result of the pre-bid meeting shall be made by the procuring agency exclusively through the issue of an Addendum pursuant to Clause IB.9 and not through the minutes of the pre-bid meeting.
- 17.4 Absence at the pre-bid meeting will not be a cause for disqualification of a bidder.

IB.18 Format and Signing of Bid

- 18.1 Bidders are particularly directed that the amount entered on the Form of Bid shall be for performing the contract strictly in accordance with the bidding documents.
- 18.2 All appendices to bid are to be properly completed and signed.
- 18.3 Alteration is not to be made neither in the form of bid nor in the Appendices thereto except in filling up the blanks as directed. If any such alterations be made or if these instructions be not fully complied with, the bid may be rejected.
- 18.4 Each bidder shall prepare by filling out the forms without alterations and shall provide an original copy along with photocopies as per the requirement of the procuring agency specified in the bidding data. The original as well as copies of the document shall be clearly marked as "ORIGINAL" and "COPY", as the case may be. If there is any discrepancy between original and copy (ies) then the original shall prevail.
- 18.5 The original and all copies of the bid shall be typed or written in indelible ink (in the case of copies, Photostats are also acceptable) and shall be signed by a person(s) duly authorized to sign on behalf of the bidder pursuant to sub- clause IB 11.1(a) hereof. All pages of the bid shall be initialed and stamped by the person(s) signing the bid.
- 18.6 The bid shall contain no alterations, omissions or additions, except to comply with instructions issued by the procuring agency, or as are necessary to correct errors made by the bidder. Such corrections shall be initialed by the person(s) signing the bid.
- 18.7 Bidders shall indicate in the space provided in the Form of Bid their full and proper postal addresses at which notices may be legally served on them and to which all correspondence in connection with their bids and the contract is to be sent.
- 18.8 Bidders should retain a copy of the bidding documents as their file copy.

D. SUBMISSION OF BIDS

IB.19 Sealing and Marking of Bids

- 19.1 Each bidder shall submit his bid as under:
- (a) ORIGINAL and COPIES of the bid shall be separately sealed and put in separate envelopes and marked as such.
 - (b) The envelopes containing the ORIGINAL and COPIES shall be put in one sealed envelope and addressed as given in sub – clause IB 19.2 hereof.
- 19.2 The inner and outer envelopes shall:
- (a) be addressed to the procuring agency at the address provided in the bidding data:
- 19.3 In addition to the identification required in sub- clause IB 19.2 hereof, the inner envelope shall indicate the name and postal address of the bidder to enable the bid to be returned unopened in case it is declared “late” pursuant to Clause IB.21
- 19.4 If the outer envelope is not sealed and marked as above, the procuring agency will assume no responsibility for the misplacement or premature opening of the Bid.

IB.20 Deadline for Submission of Bids

- 20.1 (a) Bids must be received by the procuring agency at the address specified not later than the time and date stipulated in the bidding data.
- (b) Bids with charges payable will not be accepted, nor will arrangements be undertaken to collect the bids from any delivery point other than that specified above. Bidders shall bear all expenses incurred in the preparation and delivery of bids. No claims shall be entertained for refund of such expenses.
 - (c) Where delivery of a bid is by mail and the bidder wishes to receive an acknowledgment of receipt of such bid, he shall make a request for such acknowledgment in a separate letter attached to but not included in the sealed bid package.
 - (d) Upon request, acknowledgment of receipt of bids will be provided to those making delivery in person or by messenger.
- 20.2 The Procuring Agency may, at its discretion, extend the deadline for submission of bids by issuing an amendment in accordance with IB 09. In such case, all rights and obligations of the procuring agency and the bidders shall remain the same as mentioned in the original deadline.

IB.21 Late Bids

- (a) any bid received by the procuring agency after the deadline for submission of bids prescribed in to clause IB 20 shall be returned unopened to such bidder.
- (b) delays in the mail, person in transit, or delivery of a bid to the wrong office shall not be accepted as an excuse for failure to deliver a bid at the proper place and time. It shall be the bidder’s responsibility to submit the bid in time.

IB.22 Modification, Substitution and Withdrawal of Bids

- 22.1 Any bidder may modify, substitute or withdraw his bid after bid submission provided that the modification, substitution or written notice of withdrawal is received by the procuring agency prior to the deadline for submission of bids.
- 22.2 The modification, substitution, or notice for withdrawal of any bid shall be prepared, sealed, marked and delivered in accordance with the provisions of Clause IB.19 with the outer and inner envelopes additionally marked "MODIFICATION", "SUBSTITUTION" or "WITHDRAWAL" as appropriate.
- 22.3 No bid may be modified by a bidder after the deadline for submission of bids except in accordance with to sub - clauses IB 22.1 and IB 27.2.
- 22.4 Withdrawal of a bid during the interval between the deadlines for submission of bids and the expiration of the period of bid validity specified in the Form of Bid may result in forfeiture of the bid security in pursuance to clause IB 15.

E. BID OPENING AND EVALUATION.

IB.23 Bid Opening

- 23.1 Procuring agency will open the bids, including withdrawals, substitution and modifications made pursuant to Clause IB.22, in the presence of bidders' representatives who choose to attend, at the time, date and location stipulated in the bidding data. The bidders or their representatives who are in attendance shall sign an attendance sheet.
- 23.2 Envelopes marked "MODIFICATION", "SUBSTITUTION" or "WITHDRAWAL" shall be opened and read out first. Bids for which an acceptable notice of withdrawal has been submitted pursuant to clause IB.22 shall not be opened.
- 23.3 Procuring agency shall read aloud the name of the bidder, total bid price and price of any Alternate Proposal(s), if any, discounts, bid modifications, substitution and withdrawals, the presence or absence of bid security, and such other details as the procuring agency may consider appropriate, and total amount of each bid, and of any alternative bids if they have been requested or permitted, shall be read aloud and recorded when opened.
- 23.4 Procuring Agency shall prepare minutes of the bid opening, including the information disclosed to those present in accordance with the sub-clause IB.23.3.
- 23.5 Bid shall be evaluate according to the evaluation criteria "Annexure A"

IB.24 Process to be Confidential. (SPP Rule 53)

- 24.1 Information relating to the examination, clarification, evaluation and comparison of bid and recommendations for the award of a contract shall not be disclosed to bidders or any other person not officially concerned with such process before the announcement of bid evaluation report in accordance with the requirements of Rule 45, which states that Procuring agencies shall announce the results of bid evaluation in the form of a report giving reasons for acceptance or rejection of bids. The report shall be hoisted on website of authority and that of procuring agency if it website exists and intimated to all bidders at least seven (7) days prior to the award of contract. The announcement to all bidders will include table(s) comprising read out prices, discounted prices, price adjustments made, final evaluated prices and recommendations against all the bids evaluated. Any effort by a bidder to influence the procuring agency's processing of bids or award decisions may result in the

rejection of such bidder's bid. Whereas, any bidder feeling aggrieved, may lodge a written complaint as per Rule 31; however mere fact of lodging a complaint shall not warrant suspension of the procurement process.

IB.25 Clarification of Bid (SPP Rule 43)

25.1 To assist in the examination, evaluation and comparison of bids, the procuring agency may, at its discretion, ask any bidder for clarification of the bid, including breakdowns of unit rates. The request for clarification and the response shall be in writing but no change in the price or substance of the bid shall be sought, offered or permitted except as required to confirm the correction of arithmetic errors discovered by the procuring agency in the evaluation of the bids in accordance with clause IB 28.

IB.26 Examination of Bids and Determination of Responsiveness

26.1 Prior to the detailed evaluation of bids, the procuring agency will determine whether the bidder fulfills all codal requirements of eligibility criteria given in the tender notice such as registration with tax authorities, registration with PEC (where applicable), turnover statement, experience statement, and any other condition mentioned in the NIT and bidding document. If the bidder does not fulfill any of these conditions, it shall not be evaluated further.

26.2 Once found to be fulfilling the eligibility criteria, as mentioned in sub- clause 26.1, the bids of eligible bidders will be evaluated for technical responsiveness as per specification and criteria given in the bidding documents. Technical and financial evaluations may be carried out in accordance with single stage-single one envelope, single stage-two envelopes, two stage or two stage-two envelopes bidding procedures, depending on the selection procedure adopted by the procuring agency.

26.3 A bid will be considered technically responsive if it (i) has been properly signed; (ii) is accompanied by the required bid security; and (iii) conforms to all the terms, conditions and specifications of the bidding documents, without material deviation or reservation. A material deviation or reservation is one (i) which affect in any substantial way the scope, quality or performance of the works; (ii) which limits in any substantial way, inconsistent with the bidding documents, the procuring agency's rights or the bidder's obligations under the contract; or (iii) adoption/rectification whereof would affect unfairly the competitive position of other bidders presenting substantially responsive bids.

26.4 If a bid has major deviations to the commercial requirements and technical specifications will be considered technically non responsive. As a general rule, major deviations are those that if accepted, would not fulfill the purposes for which the bid is requested, or would prevent a fair comparison or affect the ranking of the bids that are compliant with the bidding documents.

(A). Major (material) Deviations include:-

- (i) has been not properly signed;
- (ii) is not accompanied by the bid security of required amount and manner;
- (iii) stipulating price adjustment when fixed price bids were called for;
- (iv) failing to respond to specifications;
- (v) failing to comply with Mile-stones/Critical dates provided in Bidding Documents;
- (vi) sub-contracting contrary to the Conditions of Contract specified in Bidding Documents;

- (vii) refusing to bear important responsibilities and liabilities allocated in the Bidding Documents, such as performance guarantees and insurance coverage;
- (viii) taking exception to critical provisions such as applicable law, taxes and duties and dispute resolution procedures;
- (ix) a material deviation or reservation is one :
 - (a) which affect in any substantial way the scope, quality or performance of the works;
 - (b) adoption/rectification whereof would affect unfairly the competitive position of other bidders presenting substantially responsive bids.

(B) Minor Deviations

Bids that offer deviations acceptable to the Procuring Agency and which can be assigned a monetary value may be considered substantially responsive at least as to the issue of fairness. This value would however be added as an adjustment for evaluation purposes only during the detailed evaluation process.

- 26.5 If a bid is not substantially responsive, it will be rejected by the procuring agency, and may not subsequently be made responsive by correction or withdrawal of the non-conforming deviation or reservation.

IB.27 Correction of Errors before Financial Evaluation

- 27.1 Bids determined to be substantially responsive will be checked by the procuring agency for any arithmetic errors. Errors will be corrected by the procuring agency as follows:

- (a) where there is a discrepancy between the amounts in figures and in words, the amount in words will govern; and
- (b) where there is a discrepancy between the unit rate and the line item total resulting from multiplying the unit rate by the quantity, the unit rate as quoted will govern, unless in the opinion of the procuring agency there is an obviously gross misplacement of the decimal point in the unit rate, in which case the line item total as quoted will govern and the unit rate will be corrected.

- 27.2 The amount stated in the Form of Bid will be adjusted by the procuring agency in accordance with the above procedure for the correction of errors and with the concurrence of the bidders. The amount thus corrected shall be considered as binding upon the bidder. If the bidder does not accept the corrected bid price, his bid will be rejected, and the bid security shall be forfeited in accordance with sub- clause IB 15.6(b) hereof.

IB.28 Financial Evaluation and Comparison of Bids

- 28.1 The procuring agency will evaluate and compare only the Bids determined to be substantially responsive in accordance with clause IB 26.

- 28.2 In evaluating the Bids, the procuring agency will determine for each bid the evaluated bid price by adjusting the bid price as follows:

- (a) making any correction for errors pursuant to clause IB 27;

- (b) excluding provisional sums (if any), for contingencies in the Summary Bill of Quantities, but including competitively priced Day work; and
- (c) making an appropriate adjustment for any other acceptable variation or deviation.

28.3 The estimated effect of the price adjustment provisions of the conditions of contract, applied over the period of execution of the contract, shall not be taken into account in bid evaluation.

28.4 If the bid of the successful bidder is seriously unbalanced in relation to the procuring agency's estimate of the cost of work to be performed under the contract, the procuring agency may require the bidder to produce detailed price analyses for any or all items of the Bill of Quantities to demonstrate the internal consistency of those prices with the construction methods and schedule proposed. After evaluation of the price analyses, the procuring agency may require that the amount of the Performance Security set forth in clause IB.32 be increased at the expense of the successful bidder to a level sufficient to protect the procuring agency against financial loss in the event of default of the successful bidder under the contract.

28.5 Bidders may be excluded if involved in "**Corrupt and Fraudulent Practices**" means either one or any combination of the practices given below SPP Rule2(q):

- (i) "**Coercive Practice**" means any impairing or harming, or threatening to impair or harm, directly or indirectly, any party or the property of the party to influence the actions of a party to achieve a wrongful gain or to cause a wrongful loss to another party;
- (ii) "**Collusive Practice**" means any arrangement between two or more parties to the procurement process or contract execution, designed to achieve with or without the knowledge of the procuring agency to establish prices at artificial, noncompetitive levels for any wrongful gain;
- (iii) "**Corrupt Practice**" means the offering, giving, receiving or soliciting, directly or indirectly, of anything of value to influence the acts of another party for wrongful gain;
- (iv) "**Fraudulent Practice**" means any act or omission, including a misrepresentation, that knowingly or recklessly misleads, or attempts to mislead, a party to obtain a financial or other benefit or to avoid an obligation;
- (v) "**Obstructive Practice**" means harming or threatening to harm, directly or indirectly, persons or their property to influence their participation in a procurement process, or affect the execution of a contract or deliberately destroying, falsifying, altering or concealing of evidence material to the investigation or making false statements before investigators in order to materially impede an investigation into allegations of a corrupt, fraudulent, coercive or collusive practice; or threatening, harassing or intimidating any party to prevent it from disclosing its knowledge of matters relevant to the investigation or from pursuing the investigation, or acts intended to materially impede the exercise of inspection and audit rights provided for under the Rules.

28.6 Evaluation Report (SPP Rule 45)

After the completion of evaluation process, as described in clauses IB 27 and IB 28, the procuring agency shall announce the results of bid evaluation in the form of report (available on the website of the authority) giving reasons for acceptance and rejection of bid. The report shall be hoisted on website of the authority and that of procuring

agencies if its website exists and intimated to all bidders at least seven (7) days prior to the award of contract.

F. AWARD OF CONTRACT

IB.29 Award (SPP Rule 49)

29.1 Subject to clauses IB 30 and IB 34 and provision of the rule: The procuring agency shall award the contract to the bidder whose bid has been determined to be substantially responsive to the bidding documents, and who has offered the lowest evaluated bid, but not necessarily the lowest submitted price, within the original or extended period of bid validity. Provided that such bidder has been determined to be eligible in accordance with the provisions of clause IB 03 and qualify pursuant to sub-clause IB 29.2.

29.2 Procuring agency, at any stage of the bid evaluation, having credible reasons for or having *prima facie* evidence of any deficiency(ies) in contractor's capacities, may require the contractor to provide information concerning their professional, technical, financial, legal or managerial competence whether already pre-qualified or not for the said project.

Provided, that such qualification shall only be laid down after recording reasons thereof, in writing. They shall form part of the records of that bid evaluation report.

IB.30 Procuring Agency's Right to reject all Bids or Annul/Cancellation the Bidding Process (SPP Rule 25)

Notwithstanding clause IB 29 and provision of the rule: (1) A procuring agency reserves may cancel the bidding process at any time prior to the acceptance of a bid or proposal; (2) The procuring agency shall incur no liability towards bidders solely by virtue of its invoking sub –rule (1); (3) Intimation of the cancellation of bidding process shall be given promptly to all bidders and bid security shall be returned along with such intimation; (4) The procuring agency shall, upon request by any of the bidders, communicate to such bidder, grounds for cancellation of the bidding process, but is not required to justify such grounds.

IB.31. Notification/Publication of the Award of Contract (SPP Rule 25).

31.1 Prior to expiry of the period of bid validity, including extension, prescribed by the procuring agency, the procuring agency shall notify the successful bidder in writing ("Letter of Acceptance") that his bid has been accepted. This letter shall mention the sum which the procuring agency will pay to the contractor in consideration of the execution and completion of the works by the contractor as prescribed by the contract (hereinafter and in the conditions of contract called the "Contract Price").

31.2 No negotiation with the bidder having evaluated as lowest responsive or any other bidder shall be permitted, however, procuring agency may hold meetings to clarify any item in the bid evaluation report.

31.3 The notification of award and its acceptance by the bidder will constitute the formation of the contract, binding the procuring agency and the bidder till signing of the formal Contract Agreement.

31.4 Upon furnishing by the successful bidder of a Performance Security and signing of the contract, the procuring agency will promptly notify the name of the successful bidder to all bidders and return their bid securities accordingly.

31.6 Debriefing (SPP Rule 51).

(a) A bidder may ask the procuring agency for reasons for non acceptance of his bid and may request for a debriefing meeting and procuring agency shall give him the reasons for such non acceptance, either in writing or by holding a debriefing meeting with such a bidder.

(b) The requesting bidder shall bear all the costs of attending such a debriefing.

IB.32 Performance Security (SPP Rule 39)

32.1 The successful bidder shall furnish to the procuring agency a Performance Security in the form of pay order or demand draft or bank guarantee, and the amount stipulated in the bidding data and the Conditions of Contract within a period of 28 days after the receipt of Letter of Acceptance.

32.2 Failure of the successful bidder to comply with the requirements of Sub-clause IB.32.1 or clauses IB 33 or IB 35 shall constitute sufficient grounds for the annulment of the award and forfeiture of the bid security.

32.3 Validity of performance security shall extend at least ninety days beyond the date of completion of contract, or as mentioned in the bidding data to cover defects liability period or maintenance period subject to final acceptance by the procuring agency.

IB.33 Signing of Contract Agreement (SPP Rule 39)

33.1 Within 14 days from the date of furnishing of acceptable Performance Security under the Conditions of Contract, the procuring agency will send the successful bidder the Contract Agreement in the form provided in the bidding documents, incorporating all agreements between the parties.

33.2 The formal Agreement between the procuring agency and the successful bidder shall be executed within 14 days of the receipt of the Contract Agreement by the successful bidder from the procuring agency.

33.3 A procurement contract shall come into force when the procuring agency requires signs contract, the date on which the signatures of both the procuring agency and the successful bidder are affixed to the written contract. Such affixing of signatures shall take place within the time prescribed in the bidding documents.

Provided that the procuring agency may reduce the maximum time limit for signing of contract, as and when required, and shall be mentioned in the bidding documents.

33.4 Stamp Duty.

The formal Agreement between the Procuring Agency and the successful bidder shall be duly stamped at rate of 0.3% of bid price (updated from time to time) stated in Letter of Acceptance

IB.34 General Performance of the Bidders

Procuring agency may in case of consistent poor performance of the contractor and his failure to remedy the underperforming contract may take such action as may be deemed appropriate under the circumstances of the case including the rescinding the contract and/or black listing of such contractor and debarring him from participation in future bidding process.

IB.35 Integrity Pact (SPP Rule 89)

The bidder shall sign and stamp the Integrity Pact provided at Appendix-L to the bidding documents for all Provincial/Local Government procurement contracts exceeding Rupees ten million. Failure to provide such Integrity Pact shall make the bidder non-responsive.

IB.36 Instructions not Part of Contract

Bids shall be prepared and submitted in accordance with these Instructions which are provided to assist bidders in preparing their bids, and do not constitute part of the bid or the Contract Documents.

IB.37 Arbitration (SPP Rule 34)

Any dispute that is not amicably resolved shall be finally settled, unless otherwise specified in the Contract, under the Arbitration Act 1940 updated from time to time and would be held anywhere in the Province of Sindh at the discretion of procuring agency.

**BIDDING
DATA**

NOTES ON BIDDING DATA

This Section is intended to assist the procuring agency in providing the specific information in relation to corresponding clauses in Instructions to Bidders and should be prepared to suit each individual contract.

The procuring agency should provide in the bidding data information and requirements specific to the circumstances of the procuring agency, the processing of the bid, the applicable rules regarding bid price and currency, and the bid evaluation criteria that will apply to the bids. In preparing this section, the following aspects should be checked:

- (1) Information that specifies and complements the provisions of section: Instruction to Bidders must be incorporated.
- (2) Amendments and/or supplements, if any, to the provisions of Instructions to Bidders, necessitated by the circumstances of each individual contract, can be introduced only in this section since Instructions to Bidders will remain unchanged.

The following specific data for the works to be tendered shall complement, amend, or supplement the provisions in the Instructions to Bidders. Wherever there is a conflict, the provisions herein shall prevail over those in the Instructions to Bidders.

A. Method of Procurement:

Single Stage Two Envelope Procedure

- i. Bid Shall comprise of a single package containing two separate envelopes. Each envelope shall contain separately the financial proposal and technical proposal;
- ii. Envelopes shall be marked as "FINANCIAL PROPOSAL" and "TECHNICAL PROPOSAL" in bold and legible letters to avoid confusion;
- iii. Initially, only the envelope marked "TECHNICAL PROPOSAL" shall be opened;
- iv. Envelope marked as "FINANCIAL PROPOSAL" shall be retained in the custody of the procuring agency without being opened;
- v. Procuring agency shall evaluate the technical proposal in a manner prescribed in advance and as per "Annexure A", without reference to the price and reject any proposal which does not conform to the specified requirement;
- vi. No amendments in the technical proposal shall be permitted during the technical evaluation;
- vii. Financial proposals of technically qualified bids shall be opened in the presence of technically qualified bidders at a time, date and venue announced and communicated to the bidders in advance.
- viii. Financial proposal of bids found technically non-responsive shall be returned un-opened to the respective bidders; and
- ix. Bid found to be technically responsive, lowest evaluated or best evaluated bid shall be accepted.

1.1 Name of Procuring Agency:

Executive Engineer, Rural Development Department, Shaheed Benazirabad

1.2 Name of the Project and Summary of the works:

INSTALLATION OF SOLAR LIGHTS IN RURAL SINDH (SHAHEED BENAZIRABAD DIVISION)

2.1 Name of the Borrower/Source of Financing/Funding Agency/Funding Source

RURAL DEVELOPMENT DEPARTMENT, GOVERNMENT OF SINDH

B. Bid Documents

10.1 Bid language:

English

12.1 Complete set of technical information, description data, literature and drawings as required in accordance with Schedule B to Bid. This will include but not be limited to a sufficient number of drawings, photographs, catalogues, illustrations and such other information as is necessary and other relevant information about the works to be performed.

13.1 Alternative bids not permitted.

13.2 Alternative times for completion not permitted.

14.1 Period of Bid Validity:
60 days

15.1 Amount of Bid Security:
2% (Two Percent)

C. Bid Submission and Opening

18.4 Number of copies of the bid to be completed and returned:
One Original

19.2 Procuring Agency's address for the purpose of bid submission:

DG Office, Rural Development Department, Old SRTC Building, Old Wahadat Colony, Hyderabad

20.1 (a) Deadline for submission of bids:

Time 05:00 PM on 15-12-2016

(b) Venue, time, and date of bid opening:

*Venue: DG Office, Rural Development Department, Hyderabad
Time 12:00 Noon on 16-12-2016*

26.4 Responsiveness of Bids

- a) Bid is valid till period
- b) Bid prices are firm during currency of contract/price adjustment
- c) Completion period offered is within specified limits
- d) Bid does not deviate from basic technical requirement

32.1 Standard form and amount of Performance Security acceptable to the procuring agency:

5% performance security in shape of Pay Order, Call Deposit or Bank Guarantee

**FORM OF BID
AND
SCHEDULE TO BID**

FORM OF BID

Bid Reference No. _____
 (Name of Contract/Work)

To:

1. Having examined the bidding documents including Instructions to Bidders, Bidding Data, and Conditions of Contract, Specifications, Drawings and Bill of Quantities and Addenda Nos. _____ for the execution of the above-named work, we/I, the undersigned, offer to execute and complete the work and remedy any defects therein in conformity with the Conditions of Contract, Specifications, Drawings, Bill of Quantities and Addenda for the sum of Rs. _____ (Rupees _____) or such other sum as may be ascertained in accordance with the said conditions.
2. We/I understand that all the Appendices attached hereto form part of this bid.
3. As security for due performance of the undertakings and obligations of this bid, we/I submit herewith a bid security in the amount of Rupees _____ (Rs. _____) drawn in your favour or made payable to procuring agency and valid for a period of _____ days beginning from the date, bid is opened.
4. We/I undertake, if our bid is accepted, to commence the works and to complete the whole of the works comprised in the contract within the time stated in Appendix-A to Bid.
5. We/I agree to abide by this bid for the period of _____ days from the date fixed for opening the same and it shall remain binding upon us and may be accepted at any time before the expiration of that period.
6. Unless and until a formal Agreement is prepared and executed, this bid, together with your written acceptance thereof, shall constitute a binding contract between us.
7. We do hereby declare that the bid is made without any collusion, comparison of figures or arrangement with any other bidder for the works.

We understand that you are not bound to accept the lowest or any bid you may receive.

9. We undertake, if our/my bid is accepted, to execute the Performance Security referred to in Clause 10 of Conditions of Contract for the due performance of the Contract.

10. We confirm, if our bid is accepted, that all partners of the joint venture shall be liable jointly and severally for the execution of the Contract and the composition or the constitution

of the joint venture shall not be altered without the prior consent of the procuring agency.
(Please delete this in case of Bid form a single bidder)

in the capacity of _____ duly authorized to sign Bids for and on behalf of

Dated this _____ day of _____ 20

Signature: _____

(Name of Bidder in Block Capitals)
(Seal)

Address: _____

Witness:

Signature: _____
Name: _____

Address: _____

Occupation: _____

SCHEDULE TO BID INCLUDE THE FOLLOWING:

- Schedule A to Bid: Schedule of Prices
- Schedule B to Bid: Technical Specifications
- Schedule C to Bid: Specific Work Data
- Schedule D to Bid: Project understanding and knowledge
- Schedule E to Bid: Method of performing Works
- Schedule F to Bid: Special Stipulations
- Schedule G to Bid: Integrity Pact

SCHEDULE – A TO BID

SCHEDULE OF PRICES

Sr. No.

1. Preamble of Schedule of Prices
2. Schedule of Prices
 - a. Summary of Bid Prices
 - b. Bill of Quantities Item
 - c. Segregation of Price for determination of Price Element.

SCHEDULE - A TO BID

PREAMBLE TO SCHEDULE OF PRICES

1. General

- 1.1 The Schedule of Prices shall be read in conjunction with the Conditions of Contract, Contract Data together with the Specifications and Drawings, if any.
- 1.2 The Contract shall be for the whole of the works as described in these Bidding Documents. Bids must be for the complete scope of works.

2. Description

- 2.1 The general directions and descriptions of works and materials are not necessarily repeated nor summarized in the Schedule of Prices. References to the relevant sections of the Bidding Documents shall be made before entering prices against each item in the Schedule of Prices.

3. Units & Abbreviations

- 3.1 Units of measurement, symbols and abbreviations expressed in the Bidding Documents shall comply with the Systeme Internationale d' Unites (SI Units).

(Note: The abbreviations to be used in the Schedule of Prices to be defined by the Procuring Agency).

4. Rates and Prices

- 4.1 Except as otherwise expressly provided under the Conditions of Contract, the rates and amounts entered in the Schedule of Prices shall be the rates at which the Contractor shall be paid and shall be the full inclusive value of the works set forth or implied in the Contract; except for the amounts reimbursable, if any to the Contractor under the Contract.
- 4.2 Unless otherwise stipulated in the Contract Data, the premium, rates and prices entered by the bidder shall not be subject to adjustment during the performance of the Contract.
- 4.3 All duties, taxes and other levies payable by the Contractor

shall be included in the rates and prices.

- 4.4 The whole cost of complying with the provisions of the Contract shall be included in the items provided in the Schedule of Prices, and where

no items are provided, the cost shall be deemed to be distributed among the rates and prices entered for the related items of the Works and no separate payment will be made for those items.

The rates, prices and amounts shall be entered against each item in the Schedule of Prices. Any item against which no rate or price is entered by the bidder will not be paid for by the Procuring Agency when executed and shall be deemed covered by the rates and prices for other items in the Schedule of Prices.

- 4.5 The bidder shall be deemed to have obtained all information as to and all requirements related thereto which may affect the bid price.

- 4.6 The Contractor shall provide for all parts of the Works to be completed in every respect. Notwithstanding that any details, accessories, etc. required for the complete installation and satisfactory operation of the Works, are not specifically mentioned in the Specifications, such details shall be considered as included in the Contract Price.

5. Bid Prices

- 5.1 Break-up/Segregation of Bid Prices

The various elements of Bid Prices shall be quoted as detailed by the Procuring Agency in the format of Schedule of Prices.

The bidder shall recognize such elements of the costs which he expects to incur the performance of the Works and shall include all such costs in the rates and amounts entered in the Schedule of Prices.

- 5.2 Total Bid Price

The total of bid prices in the Schedule of Prices shall be entered in the Summary of Bid Prices.

6. Provisional Sums and Day work

- 6.1 Provisional Sums included and so designated in the Schedule of Prices if any, shall be expended in whole or in part at the direction and discretion of the Engineer/Procuring Agency. The Contractor will only receive payment in respect of Provisional Sums, if he has been instructed by the Engineer/Procuring Agency to utilize such sums.

- 6.2 Day work rates in the contractor's bid are to be used for small additional amounts of work and only when the Engineer have given written instructions in advance for additional work to be paid for in that way.

SCHEDULE - A TO BID

SUMMARY OF BID PRICES

INSTALLATION OF SOLAR LIGHTS IN RURAL SINDH – SHAHEED BENAZIRABAD DIVISION

DESCRIPTIONS	QTY	UNIT	Rate	Amount
Supply and Installation of approved The Solar LED Light with Removable 33Ah Lithium Battery cartridge. A built in Intelligent Energy Management Controller with auto on/off, Adaptive light level control and wireless remote management system with data sim (data sim for 2 years). All high Efficient 120W solar module and 72W LED light head with maximum of 7500 lumens should be fully integrated into the Light with automatic/robotic solar panel cleaning system; Hot Dip Galvanized shaft / tubular Pole single head 8 Meter with required foundation and accessories i.e. fasteners etc . as per approval of engineer incharge.	2,500	Set		

NOTE :-

Rate / quantities should be changed after technical sanction received from competent authority.

Segregation of Price for determination of Price Element.

DESCRIPTIONS	QTY	UNIT	Rate			Amount		
			Supply	Service	Total	Supply	Service	Total
Supply and Installation of approved The Solar LED Light with Removable 33Ah Lithium Battery cartridge. A built in Intelligent Energy Management Controller with auto on/off, Adaptive light level control and wireless remote management system with data sim (data sim for 2 years). A High Efficient 120W solar module and 72W LED light head with maximum of 7500 lumens should be fully integrated into the Light with automatic/robotic solar panel cleaning system: Hot Dip Galvanized shaft / tubular Pole single head 8 Meter with required foundation and accessories i.e. fasteners etc . as per approval of engineer incharge.	2.500	Set						

SCHEDULE - A TO BID**BILL OF QUANTITY (ITEMS)**

S.NO	DESCRIPTION	QTY	UNIT
1)	Supply & Installation of The Solar LED Light with Removable 33Ah Lithium Battery cartridge. A built in Intelligent Energy Management Controller with auto on/off, Adaptive light level control and wireless remote management system with data sim (data sim for 2 years). A High Efficient 120W solar module and 72W LED light head with maximum of 7500 lumens should be fully integrated into the Light etc complete with automatic/robotic solar panel cleaning system as per approval of Engineer In-Charge	2.500	EACH
2)	Supply and Installation of hot dip galvanized shaft / tubular Single Head 8 meter height, pole top dia 80 mm bottom dia 101.60 mm wall thickness 3.25 mm with required foundation and accessories(complete) as per approval of Engineer In-Charge	2.500	EACH

SCHEDULE - B TO BID

Technical Specification

The Solar Street Light should have the following mandatory key features

- ❖ Integrated All-in-One design
- ❖ Adaptive energy management system
- ❖ Easily removable battery for in place pack replacement
- ❖ Battery technology used should be LiFePo4
- ❖ Advanced custom optics
- ❖ High efficiency luminaire 180lm/W
- ❖ Automatic/Robotic Solar Panel Cleaning System which will work during peak hours daily cleaning
- ❖ Adaptive programmable light profiles
- ❖ Programmable 3 step Dimming
- ❖ Each light to have built-in Wireless communication Interface
- ❖ Mesh Networking to provide resilience
- ❖ Wide area street networking management, monitoring and control
- ❖ LED Power rating 72 Watts (Drive at 42W for 7,500 Lumens)
- ❖ Rated Lumens 180lm
- ❖ System Lumen hours Approx 70,000
- ❖ Pole Height 8m
- ❖ Pole spacing 35m
- ❖ CE marked
- ❖ All components must be as a minimum IP66 rated

Technical Parameters of the Solar Light

A. General

The required solar street light system should be autonomous requiring no additional power source beyond that provided by the solar Photovoltaic cells incorporated into each individual light.

The lamp should switch on automatically when natural light falls below a specified light level and switch off automatically when natural light reaches a pre-specified level.

With an intelligent energy management controller, the system should have at least 3 operating phases during the night where the light levels and the duration of each phase must be programmable for the period of illumination.

Each Light must have an electronically readable **Unique Identification number**

Each light system must consist of an integrated light fixture, Energy Management Controller and battery assembly mounted on a pole 8M height.

The Solar Street Lighting system must be controllable through a built in wireless interface that can create a mesh type resilient network between the installed lights.

A communication gateway with Data Sim option must be available that can manage a minimum of 100 lights. A central management system (CMS) must also be available that manage an unlimited number of gateways over the internet or GSM.

The street light design should be aesthetically pleasing and the orientation should follow the road contour "Drawings"

The light should require minimum effort for installation and maintenance.

The solar street light should consist of parts:

1. A single modular housing for the:
 - PV Module,
 - LED Luminaire
 - Easily removable Maintenance free Battery
 - Energy Management Controller
 - An automatic / robotic cleaning system for solar panels on each unit
2. A Hot Dip Galvanized Shaft/Tubular pole with fitting and accessories for Integrated Light
3. A Wireless Management System with Data Sim Option

B. Functional and Physical Specifications

1. Mechanical Requirements

The street light shall consist of following components:

- The Solar LED Light comprising a Solar Photovoltaic Module, a LED Light, a Battery, a Energy Management Controller and Remote wireless System with Data Sim Option
- 8m high Mounting Pole

2. Detailed Specifications of Solar LED Light

Solar Photovoltaic Module

- 120W High Efficiency Mono Crystalline Technology
- High Efficiency Rating
- A lifespan of > 25 years
- A single module type shall be used for the whole project
- The module housing shall be made of corrosion resistant material

LED Light

- Maximum Light output: 7500 Lumens in full brightness phase
- Must have Standard phase, Full Brightness phase and Economy phase
- Light Level and length of each phase must be user settable
- Light Source Type: High efficiency LED, 5000K to 6500K colour temperature
- LED Power: $\geq 72W$
- Applicable Pole Spacing: Up to 5 x Pole Height

Battery Module

- Battery Type: Lithium LifePO4
- Capacity: $\geq 12.8V$ 33Ah
- Battery Life: 5yrs at 80% DoD at 45°C
- To minimize the effort for maintenance, the battery module must be of a cartridge type so allowing single person to swiftly remove, replace and secure the battery.

Fully Integrated Energy Management Controller

The Energy Management controller must:

- Monitor the Battery Voltage
- Wirelessly provide Voltage information
- Monitor and Control the Load Voltage
- Monitor and Control the Load Current
- Monitor and control fault
- Protect the battery from over charge and deep discharge
- Be consistent with the requirements of the other components in the integrated modular lamp
- Be capable of wirelessly updating its control software
- Be programmable for regulating and monitoring the solar power, battery and illumination to manage light intensity as a function of available energy
- Be capable of forcing the lights "On" and "Off" remotely
- Allow remote management through internet or GSM connection
- Smart on/off control of lights based upon ambient light conditions

Remote Monitoring Option

- **Wireless Network:** The remote monitoring system must allow the monitoring of sectors of lights which will communicate via GSM or internet and be accessible remotely through these mediums; there will be one gateway for every 100 lights with all gateways reporting to a central control room which can manage an unlimited number of such gateways.
- **Maintain:** Log of each light under gateway if there is problem.
- **Fault Management:** The software has the capability to send SMS/Email to the maintenance staff for the particular faulty light with the location for troubleshooting if required by the administrator. This feature will save the time and maintain history of the lights.
- **Light Hours:** Programmable trigger levels for determining Dusk and Dawn conditions.

Description of Equipment

Solar PV Module Details

Technology	High Efficient Solar PV Module
Power rating	Total 120W

Battery Pack Specifications

Technology	LiFePo4
Capacity (Wh)	422.4 Wh
Capacity (Ah)	33 Ah
Voltage	12.8V DC nominal
Operational Life	5 – 7 years
Battery Warranty	2 years
Battery charge / discharge cycles	Greater than 2000 cycles
Operating temperature	-10°C to +80°C
Battery management – DOD, Charge, discharge, cycles	Microprocessor based Intelligent Energy Management System (EMS)

Solar Energy Management System

(Fully Integrated Energy Management Controller and Wireless interface)

Technology (EMS)	state-of-the-art custom design
Functionality	Complete Energy Management System (EMS) Twin controller design

Functionality – Battery	Battery management - charge, discharge and DOD
Functionality – Solar	Solar Maximum power point tracking (MPPT)
Functionality – Luminaire	Adaptive luminaire custom light and duration output with user profiling Dusk to Dawn, hours , fixed custom options
Functionality – Networking	Wide area street lighting mesh networking
Dimming capability	A three step programmable facility 4 hr = 100% (7500 lm) 4 hr = 50% (3750 lm) 4 hr = 25% (1875 lm)
Protection	Reverse polarity protection Short circuit protection for panel and load terminals Over discharge protection Over voltage disconnection Low voltage panel and battery disconnects Automatic electronic fuse protection Over current protection Reverse current protection Over temperature protection
Life	10 years or more
Warranty	2 years
Operating temperature	-10°C to +80°C

Luminaire Specification

Integrated design	Luminaries integrated as part of the light
LED Power	72 W max (Drive at 42W)
Number of LED's	48
Maximum light output (lumens)	12,960
LED Efficiency	180 lumen / Watt
LED Life Time	>50,000hrs
LED colour temperature	6000-6500K
Average light level	22 Lux
Minimum light level	12 Lux
Maximum Light level	26 Lux
Pole height	8-10m
Warranty	2 years
Operating temperature	-10°C to +60°C

Pole and Support Structure

Corrosion Protection	Pole hot dipped galvanized steel with min 110 micron coating
Measurement and type	Height 8 meter single head shaft/tubular Top Dia 80mm Bottom Dia 101.60 Wall Thickness 3.25 mm
Pole / mounting details	Foundation as per drawing
Pole spacing	35 m
Service life	25 years

DRAWINGS

LIGHT FIXTURE

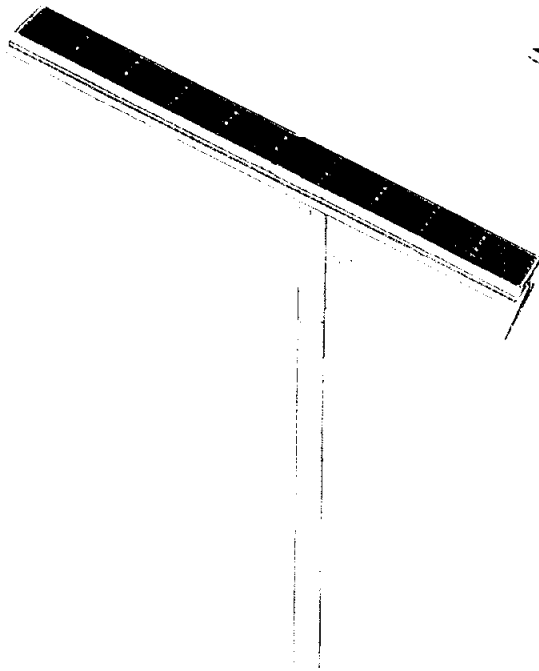
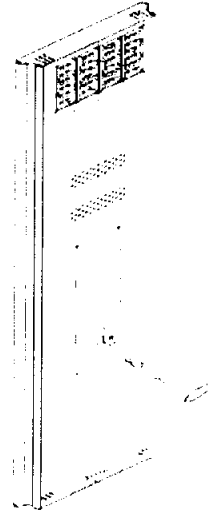
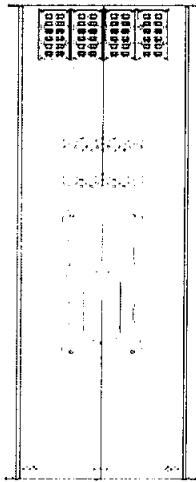

SIMULATION OF STREET LIGHT

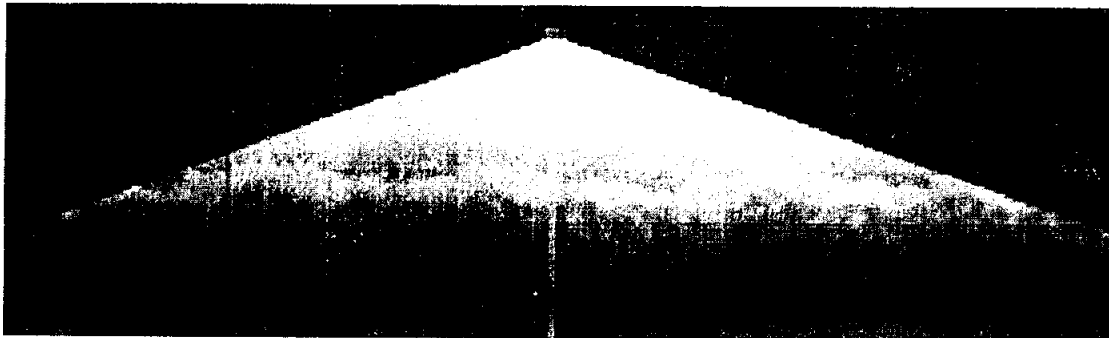
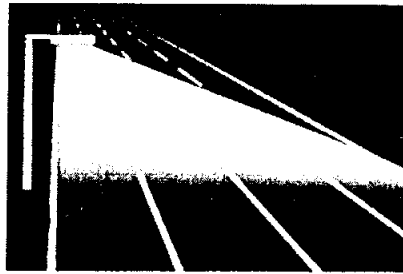
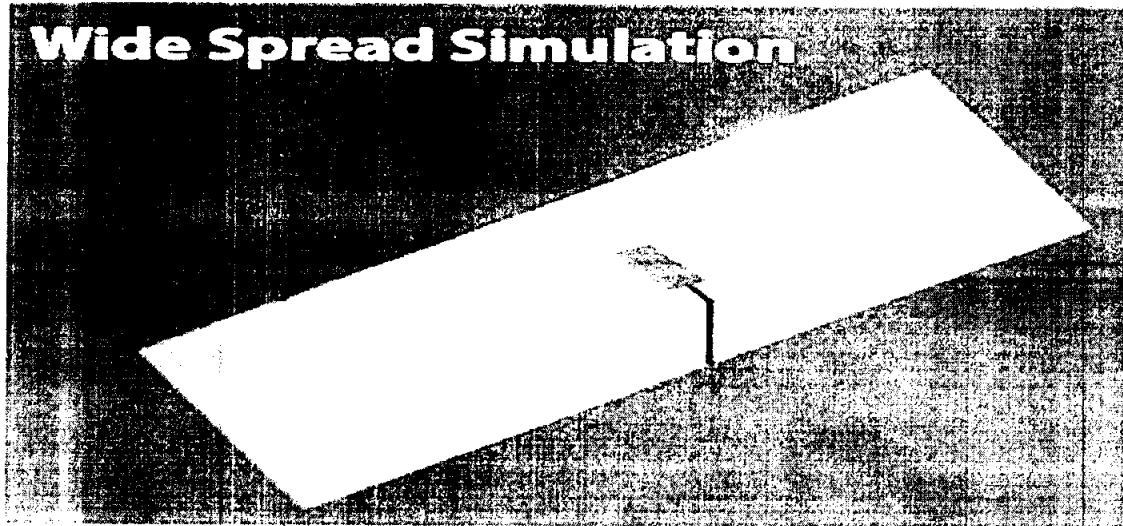

AUTOMATIC / ROBOTIC SOLAR PANEL CLEANING SYSTEM

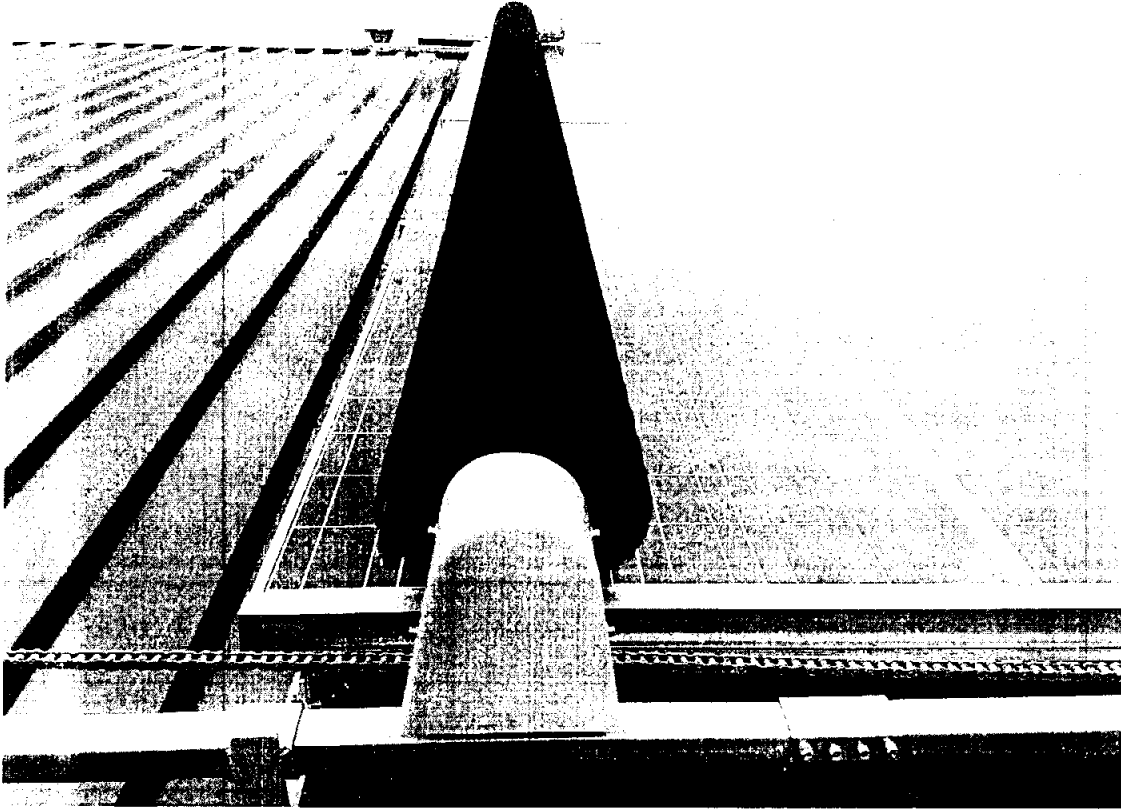

WIRELESS INTERFACE MESH TYPE

Diagram

1. The system is designed to be used in a wide range of environments, including indoor and outdoor settings. It is suitable for use in areas with high levels of dust and dirt, such as construction sites and industrial facilities.

2. The system is designed to be used in a wide range of environments, including indoor and outdoor settings. It is suitable for use in areas with high levels of dust and dirt, such as construction sites and industrial facilities.

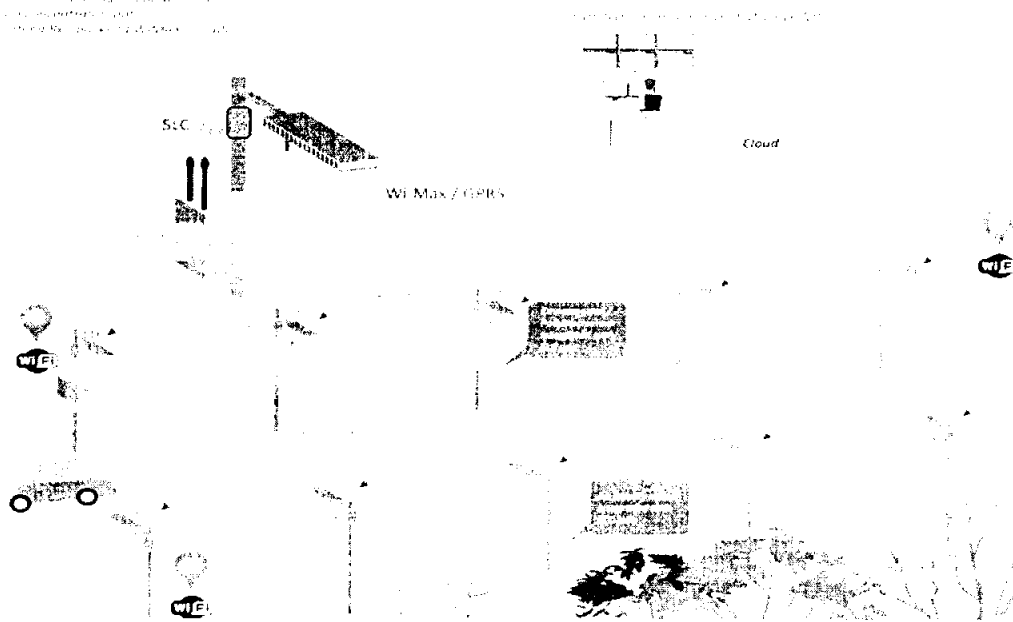

CENTRAL MONITORING SYSTEM

REAL TIME MONITORING OF SOLAR LED LIGHT OVER INTERNET

SBA 100	HYD 100	MPK 100	LARKANA 100	SUKKHUR 100	KHI 100
Gateway Device	Gateway Device	Gateway Device	Gateway Device	Gateway Device	Gateway Device
Data SIM	Data SIM	Data SIM	Data SIM	Data SIM	Data SIM
Mobile Tower	Mobile Tower	Mobile Tower	Mobile Tower	Mobile Tower	Mobile Tower

SERVER

CENTRAL MONITORING SYSTEM (CMS)

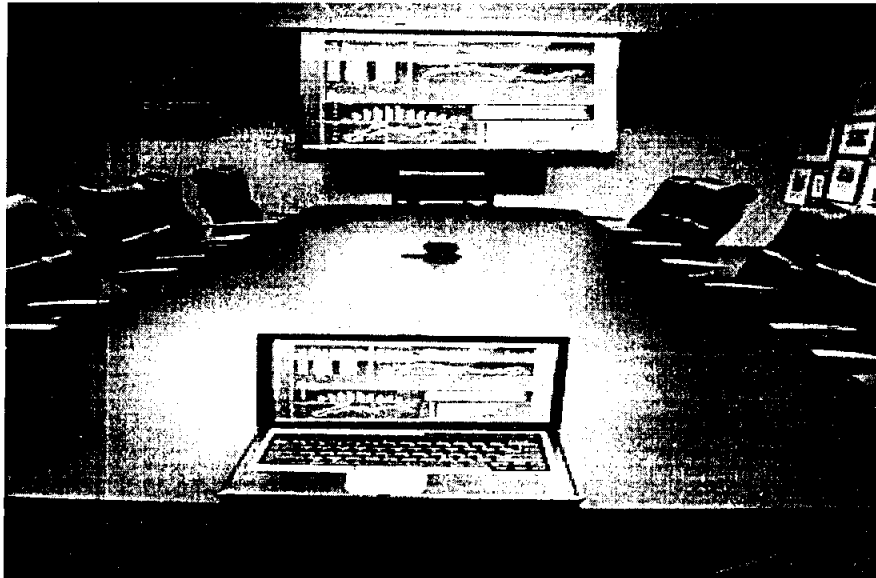

SCHEDULE - C TO BID

SPECIFIC WORKS DATA

a. Bidders shall fill specifications of Solar LED lights offered by them in following table:

ITEM	SPECIFICATION REQUIRED	OFFERED
1. Solar PV Module Details	120W High Efficient Solar PV Module	
2. Battery Pack Specifications	12.8V 33AH LiFePo4; 2 years warranty; Operating temperature - 10°C to +80°C; Greater than 2000 cycles; To minimize the effort for maintenance, the battery module must be of a cartridge type so allowing single person to swiftly remove, replace and secure the battery.	
3. Fully Integrated Energy Management Controller and Wireless interface	state-of-the-art custom design Microprocessor based Complete Energy Management System (EMS) Twin controller design; Wireless interface; Battery management - charge, discharge and DOD; Solar Maximum power point tracking; Adaptive luminaire custom light and duration output with user profiling Dusk to Dawn, hours , fixed custom options; A three step programmable facility 4 hr = 100% (7500 lm) 4 hr = 50% (3750 lm) 4 hr = 25% (1875 lm); Reverse polarity protection Short circuit protection for panel and load terminals Over discharge protection Over voltage disconnection Low voltage panel and battery disconnects Automatic electronic fuse protection Over current protection Reverse current protection Over temperature protection;	

<p>4. Luminaire Specification</p>	<p>Luminaries integrated as part of the light 72 W max (Drive at 42W; 180 lumen / Watt; Life >50,000hrs; 6000-6500K; Emin 15Lux, Eav 22Lux and Emax 26Lux Coverage pole to pole spacing 35 meters</p>	
<p>5. Solar Panel Cleaning</p>	<p>Automatic / Robotic Solar Panel Cleaning System only through solar panel energy, which will work during peak hours daily cleaning.</p>	
<p>6. Remote Monitoring Option</p>	<p>Remote wireless management system through internet with Data Sim Option;</p> <p>Real Time monitoring: Monitor light operation; Monitor the Battery Voltage; Monitor Voltage information; Monitor and Control the Load Voltage; Monitor and Control the Load Current; Monitor and control fault; Be capable of wirelessly updating its control software; Be capable of forcing the lights "On" and "Off" remotely;</p> <p>Wireless Network: The remote monitoring system must allow the monitoring of sectors of lights which will communicate via GSM or internet and be accessible remotely through these mediums; there will be one gateway for every 100 lights with all gateways reporting to a central control room which can manage an unlimited number of such gateways;</p> <p>Maintain: Log of each light under gateway if there is problem;</p> <p>Fault Management: The software has the capability to send SMS/Email to the maintenance staff for the particular faulty light with the location for troubleshooting if</p>	

	<p>required by the administrator. This feature will save the time and maintain history of the lights;</p> <p>Light Hours: Programmable trigger levels for determining Dusk and Dawn conditions.</p>	
7. Pole and Support Structure	<p>Pole hot dipped galvanized steel with min 110 micron coating;</p> <p>Shaft / Tubular Single Head 8 meter height, pole top dia 80mm bottom dia 101.60</p> <p>Wall Thickness 3.25 mm with required foundation and accessories</p>	
8. Repair & Maintenance	<p>2 years warranty of complete system</p>	

Project Understanding and Knowledge

Method of performing Works

Schedule-F to Bid

SPECIAL STIPULATIONS
Clause
Conditions of Contract

1	Amount of Performance Security	5% of Contract Amount, Total amount including performance security and retention deducted should not exceed 9% of contract price state in the letter of acceptance
2	Time for Furnishing Program	within (fifteen) 15 days from the date of receipt of letter of acceptance
3	Commencement of Work	within (fourteen) 14 days after signing contract agreement
4	Date of Completion	30th June 2017
5	Warranty	2 Years limited warranty
5	Percentage of Retention Money	4% of Contract Amount
6	Limit of Retention Money	4% of Contract Amount
7	Payment Terms as follows:	
7.1	5% of the total contract cost shall be released against Mobilization advance Guarantee of equivalent percentage.	
7.2	40% of contract value shall be released on submission of confirmation letter from the bank opening of letter of credit subject to deduction of mobilization advance proportionately (if mobilization availed.)	
7.3	10% of contract value shall be released on submission of bill of lading subject to deduction of mobilization advance proportionately (if mobilization availed.)	
7.4	35% of contract value shall be released on submission of prove of good deliver at site mentioned on work order subject to deduction of mobilization advance proportionately. (if mobilization availed.)	
7.5	11% of contract value shall be released on submission of FINAL bill subject to deduction of mobilization advance proportionately. (if mobilization availed.)	
7.5	4% of contract value will be release on successful completion period	

(INTEGRITY PACT)

DECLARATION OF FEES, COMMISSION AND BROKERAGE ETC; PAYABLE BY CONTRACTORS.

(FOR CONTRACTS WORTH RS. 10.00 MILLION OR MORE)

Contract No. _____ Dated _____
Contract Value: _____
Contract Title: _____

..... [name of Contractor] hereby declares that it has not obtained or induced the procurement of any contract, right, interest, privilege or other obligation or benefit from Government of Sindh (GoS) or any administrative subdivision or agency thereof or any other entity owned or controlled by it (GoS) through any corrupt business practice.

Without limiting the generality of the foregoing, [name of Contractor] represents and warrants that it has fully declared the brokerage, commission, fees etc. paid or payable to anyone and not given or agreed to give and shall not give or agree to give to anyone within or outside Pakistan either directly or indirectly through any natural or juridical person, including its affiliate, agent, associate, broker, consultant, director, promoter, shareholder, sponsor or subsidiary, any commission, gratification, bribe, finder's fee or kickback, whether described as consultation fee or otherwise, with the object of obtaining or inducing the procurement of a contract, right, interest, privilege or other obligation or benefit in whatsoever form from, from Procuring Agency (PA) except that which has been expressly declared pursuant hereto.

[name of Contractor] accepts full responsibility and strict liability that it has made and will make full disclosure of all agreements and arrangements with all persons in respect of or related to the transaction with PA and has not taken any action or will not take any action to circumvent the above declaration, representation or warranty.

[name of Contractor] accepts full responsibility and strict liability for making any false declaration, not making full disclosure, misrepresenting facts or taking any action likely to defeat the purpose of this declaration, representation and warranty. It agrees that any contract, right, interest, privilege or other obligation or benefit obtained or procured as aforesaid shall, without prejudice to any other rights and remedies available to PA under any law, contract or other instrument, be voidable at the option of PA.

Notwithstanding any rights and remedies exercised by PA in this regard, [name of Supplier/Contractor/Consultant] agrees to indemnify PA for any loss or damage incurred by it on account of its corrupt business practices and further pay compensation to PA in an amount equivalent to ten times the sum of any commission, gratification, bribe, finder's fee or kickback given by [name of Contractor] as aforesaid for the purpose of obtaining or inducing the procurement of any contract, right, interest, privilege or other obligation or benefit in whatsoever form from PA.

.....
[Procuring Agency]

[Contractor]

FORMS

**BID SECURITY
PERFORMANCE SECURITY
CONTRACT AGREEMENT
MOBILIZATION ADVANCE GUARANTEE**

BID SECURITY
(Bank Guarantee)

Security Executed on _____
(Date)

Name of Surety (Bank) with Address: _____
(Scheduled Bank in Pakistan)

Name of Principal (Bidder) with Address _____

Penal Sum of Security Rupees. _____ (Rs. _____)
Bid Reference No. _____

KNOW ALL MEN BY THESE PRESENTS, that in pursuance of the terms of the bid and at the request of the said Principal (Bidder) we, the Surety above named, are held and firmly bound unto _____

(hereinafter called the 'Procuring Agency') in the sum stated above for the payment of which sum well and truly to be made, we bind ourselves, our heirs, executors, administrators and successors, jointly and severally, firmly by these presents.

THE CONDITION OF THIS OBLIGATION IS SUCH, that whereas the Bidder has submitted the accompanying bid dated _____ for Bid No. _____ for _____ (Particulars of Bid) to the said Procuring Agency; and

WHEREAS, the Procuring Agency has required as a condition for considering said bid that the **bidder** furnishes a bid security in the above said sum from a Scheduled Bank in Pakistan or from a foreign bank duly counter-guaranteed by a Scheduled Bank in Pakistan, to the procuring agency, conditioned as under:

- (1) that the bid security shall remain in force up to and including the date 28 days after the deadline for validity of bids as stated in the Instructions to bidders or as it may be extended by the procuring agency, notice of which extension(s) to the Surety is hereby waived;
- (2) that the bid security of unsuccessful bidders will be returned by the procuring agency after expiry of its validity or upon signing of the Contract Agreement; and
- (3) that in the event of failure of the successful bidder to execute the proposed Contract Agreement for such work and furnish the required Performance Security, the entire said sum be paid immediately to the said procuring agency pursuant to Clause 15.6 of the Instruction to bidders for the successful bidder's failure to perform.

NOW THEREFORE, if the successful bidder shall, within the period specified therefor, on the prescribed form presented to him for signature enter into a formal Contract with the said procuring agency in accordance with his bid as accepted and furnish within twenty eight (28) days of his being requested to do so, a Performance Security with good and sufficient surety, as may be required, upon the form prescribed by the said procuring agency for the faithful performance and proper fulfilment of the said Contract or in the event of non-withdrawal of the said bid within the time specified for its validity then this obligation shall be void and of no effect, but otherwise to remain in full force and effect.

PROVIDED THAT the Surety shall forthwith pay the procuring agency, the said sum upon first written demand of the procuring agency (without cavil or argument) and without requiring the procuring agency to prove or to show grounds or reasons for such demand.

notice of which shall be sent by the procuring agency by registered post duly addressed to the Surety at its address given above.

PROVIDED ALSO THAT the procuring agency shall be the sole and final judge for deciding whether the Principal (Bidder) has duly performed his obligations to sign the Contract Agreement and to furnish the requisite Performance Security within the time stated above, or has defaulted in fulfilling said requirements and the Surety shall pay without objection the said sum upon demand from the procuring agency forthwith and without any reference to the Principal (Bidder) or any other person.

IN WITNESS WHEREOF, the above bounden Surety has executed the instrument under its seal on the date indicated above, the name and seal of the Surety being hereto affixed and these presents duly signed by its undersigned representative pursuant to authority of its governing body.

SURETY (Bank)

WITNESS:

Signature _____

1. _____

Name _____

Title _____

Corporate Secretary (Seal)

Corporate Guarantor (Seal)

2. _____

Name, Title & Address

**FORM OF PERFORMANCE SECURITY
(Bank Guarantee)**

Guarantee No. _____
Executed on _____
Expiry date _____

[Letter by the Guarantor to the Procuring Agency]

Name of Guarantor (Bank) with address: _____
(Scheduled Bank in Pakistan)

Name of Principal (Contractor) with address: _____

Penal Sum of Security (express in words and figures) _____

Letter of Acceptance No. _____ Dated _____

KNOW ALL MEN BY THESE PRESENTS, that in pursuance of the terms of the bidding documents and above said Letter of Acceptance (hereinafter called the Documents) and at the request of the said Principal we, the Guarantor above named, are held and firmly bound unto the _____ (hereinafter called the procuring agency) in the penal sum of the amount stated above for the payment of which sum well and truly to be made to the said procuring agency, we bind ourselves, our heirs, executors, administrators and successors, jointly and severally, firmly by these presents.

THE CONDITION OF THIS OBLIGATION IS SUCH, that whereas the Principal has accepted the procuring agency's above said Letter of Acceptance for _____ (Name of Contract) for the _____ (Name of Project).

NOW THEREFORE, if the Principal (Contractor) shall well and truly perform and fulfill all the undertakings, covenants, terms and conditions of the said Documents during the original terms of the said Documents and any extensions thereof that may be granted by the procuring agency, with or without notice to the Guarantor, which notice is, hereby, waived and shall also well and truly perform and fulfill all the undertakings, covenants terms and conditions of the Contract and of any and all modifications of said Documents that may hereafter be made, notice of which modifications to the Guarantor being hereby waived, then, this obligation to be void; otherwise to remain in full force and virtue till all requirements of Clause 49, Defects Liability, of Conditions of Contract are fulfilled.

Our total liability under this Guarantee is limited to the sum stated above and it is a condition of any liability attaching to us under this Guarantee that the claim for payment in writing shall be received by us within the validity period of this Guarantee, failing which we shall be discharged of our liability, if any, under this Guarantee.

We, _____ (the Guarantor), waiving all objections and defenses under the Contract, do hereby irrevocably and independently guarantee to pay to the procuring agency without delay upon the procuring agency's first written demand without

cavil or arguments and without requiring the procuring agency to prove or to show grounds or reasons for such demand any sum or sums up to the amount stated above, against the procuring agency's written declaration that the Principal has refused or failed to perform the obligations under the Contract which payment will be effected by the Guarantor to Procuring Agency's designated Bank & Account Number.

PROVIDED ALSO THAT the procuring agency shall be the sole and final judge for deciding whether the Principal (Contractor) has duly performed his obligations under the Contract or has defaulted in fulfilling said obligations and the Guarantor shall pay without objection any sum or sums up to the amount stated above upon first written demand from the procuring agency forthwith and without any reference to the Principal or any other person.

IN WITNESS WHEREOF, the above-bounden Guarantor has executed this Instrument under its seal on the date indicated above, the name and corporate seal of the Guarantor being hereto affixed and these presents duly signed by its undersigned representative, pursuant to authority of its governing body.

	----- Guarantor (Bank)
Witness:	
1. -----	Signature -----
----- Corporate Secretary (Seal)	Name -----
	Title -----
2. -----	
----- Name, Title & Address	----- Corporate Guarantor (Seal)

FORM OF CONTRACT AGREEMENT

THIS CONTRACT AGREEMENT (hereinafter called the "Agreement") made on the _____ day of _____ (month) 20____ between _____ (hereafter called the "Procuring Agency") of the one part and _____ (hereafter called the "Contractor") of the other part.

WHEREAS the Procuring Agency is desirous that certain works, viz _____ should be executed by the Contractor and has accepted a bid by the Contractor for the execution and completion of such works and the remedying of any defects therein.

NOW this Agreement witnesseth-- as follows:

1. In this Agreement words and expressions shall have the same meanings as are respectively assigned to them in the Conditions of Contract hereinafter referred to.
2. The following documents after incorporating addenda, if any, except those parts relating to Instructions to bidders shall be deemed to form and be read and construed as part of this Agreement, viz:
 - (a) The Contract Agreement;
 - (b) The Letter of Acceptance;
 - (c) The completed Form of Bid;
 - (d) The Special Conditions of Contract -- Part II;
 - (e) The General Conditions -- Part I;
 - (f) The Completed Schedule to Bid (B.C.D) including Schedule of Price (A);
 - (g) The Integrity Pact (Appendix-B to Bid);
 - (h) The Bill of Quantity
 - (i) The Drawings;
 - (j) The Specifications.
 - (k) _____ (any other)
3. In consideration of the payments to be made by the procuring agency to the Contractor as hereinafter mentioned, the Contractor hereby covenants with the procuring agency to execute and complete the works and remedy defects therein in conformity and in all respects with the provisions of the contract.
4. Procuring agency hereby covenants to pay the contractor, in consideration of the execution and completion of the works as per provisions of the contract, the contract Price or such other sum as may become payable under the provisions of the contract at the times and in the manner prescribed by the contract.

IN WITNESS WHEREOF the parties hereto have caused this Agreement to be executed on the day, month and year first before written in accordance with their respective laws.

Signature of the Contactor

Signature of Procuring Agency

(Seal)

(Seal)

Signed, Sealed and Delivered in the presence of:

Witness:

(Name, Title and Address)

Witness:

(Name, Title and Address)

MOBILIZATION ADVANCE GUARANTEE

Bank Guarantee No. _____ Date _____

WHEREAS _____ (hereinafter called the 'Procuring Agency') has entered into a Contract for _____ (Particulars of Contract) with _____ (hereinafter called the "Contractor").

AND WHEREAS, the Procuring Agency has agreed to advance to the Contractor, at the Contractor's request, an amount of Rupees _____ (Rs _____) which amount shall be advanced to the Contractor as per provisions of the Contract.

AND WHEREAS, the Procuring Agency has asked the Contractor to furnish Guarantee to secure the mobilization advance for the performance of his obligations under the said Contract.

AND WHEREAS, _____ (Scheduled Bank in Pakistan)

(hereinafter called the "Guarantor") at the request of the Contractor and in consideration of the **procuring agency** agreeing to make the above advance to the Contractor, has agreed to furnish the said Guarantee.

NOW, THEREFORE, the Guarantor hereby guarantees that the Contractor shall use the advance for the purpose of above mentioned Contract and if he fails and commits default in fulfilment of any of his obligations for which the advance payment is made, the Guarantor shall be liable to the procuring agency for payment not exceeding the aforementioned amount.

Notice in writing of any default, of which the procuring agency shall be the sole and final judge, on the part of the Contractor, shall be given by the procuring agency to the Guarantor, and on such first written demand, payment shall be made by the Guarantor of all sums then due under this Guarantee without any reference to the Contractor and without any objection.

This Guarantee shall remain in force until the advance is fully adjusted against payments from the Interim Payment Certificates of the Contractor or until

_____ whichever is earlier. (Date)
 The Guarantor's liability under this Guarantee shall not in any case exceed the sum of Rupees _____ (Rs _____).

This Guarantee shall remain valid up to the aforesaid date and shall be null and void after the aforesaid date or earlier if the advance made to the Contractor is fully adjusted against payments from Interim Payment Certificates of the Contractor provided that the Guarantor agrees that the aforesaid period of validity shall be deemed to be extended if on the above mentioned date the advance payment is not fully adjusted.

GUARANTOR

1. Signature _____
2. Name _____
3. Title _____

WITNESS

1. _____
Corporate Secretary (Seal)

2. _____
(Name Title & Address)

Corporate Guarantor (Seal)

S.NO.	CRITERIA	MAX MARKS
A	COMPANY PROFILE (i) Number of years 10 Years - 6 Marks 5 Years - 3 Marks	6
B	FINANCIAL CAPABILITY (i) 600 Million or more - 4 Marks (ii) 300 Million or more - 2 Marks	4
C	GENERAL / SPECIFIC EXPERIENCE (i) Public Sector - 4 Marks (ii) Private Sector - 1 Marks	4
D	MACHINERY & EQUIPMENT D (i) Similar Nature of project executed with the contract value greater than 300 Million - 10 Marks D (ii) Similar Nature of project executed with the contract value less than 300 Million - 5 Marks	10
E	TECHNCIAL PROPOSAL (A) AUTHORIZED DISTRIBUTOR / SOLE AGENT / DEALER	
	A (i) Solar Panel Manufacturer Certifications (ISO, IEC, RoHS, TUV, CE etc)	2
	A (ii) LED light Manufacturer Certifications (ISO, IEC, RoHS, TUV, CE etc)	2
	A (iii) Battery Manufacturer "Lithium LifePO4 Battery" Certifications (ISO, IEC, RoHS, TUV, CE etc)	2
	A (iv) Electronics & Automation Certifications (ISO, IEC, RoHS, TUV, CE etc)	2
	(B) SPECIFICATION B (i) Integrated Solar LED Light 72W @ Drive Power 42W B (ii) Fully integrated Energy Management Controller B (iii) Builtin Wireless interface B (iv) Lithium LifePO4 Battery, greater than 2000 cycles (removable cartridge) B (v) Pole to Pole Spacing @ 35 Meters	2 2 2 2 2
	(C) SPECIALIZATION C (i) Wireless connectivity gateway with data sim C (ii) Automatic / Robotic Solar Panel Cleaning	6 10
F	UNDERSTANDING OF PROJECT REQUIREMENT AND PROJECT PLAN Participant must establish by submitted documents and write-ups that they have understanding of project requirements and shall submit its detailed project plan for the subject project. The submitted material would be evaluated for Participant understanding of the project	8

G	PROPOSED METHODOLOGY/SOLUTION AND COMPLIANCE Participant must submit a detailed project methodology meeting the procuring agency requirements. The submitted methodology would be evaluated for participant understanding of project. The offered solution would be evaluated against the requirements of the assignment.	8
H	REPAIR, OPERATION & MAINTENANCE Repair & Maintenance for two (02) years after commissioning of the Solar LED Light. (i) Participant must submit an affidavit on registered stamp paper duly attested by notary public. - 4 Marks (ii) Clearly defined support and escalation procedures in place. - 2 Marks	6
I	DEMONSTRATION AND SAMPLE AS PER REQUIRED SPECIFICATION The Sample shall submit alongwith the bidding/tender documents on the bid submission date	20

TOTAL MARKS

100

QUALIFYING MARKS

80

GENERAL CONDITIONS OF CONTRACT

TABLE OF CONTENTS

CONDITIONS OF CONTRACT

<i>Clause No</i>	<i>Description</i>
1.	General Provisions
2.	The Procuring Agency
3.	Engineer's/Procuring Agency's Representatives
4.	The Contractor
5.	Design by Contractor
6.	Procuring Agency's Risks
7.	Time for Completion
8.	H a n d i n g / Taking Over
9.	Remedying Defects
10.	Variations and Claims
11.	Contract Price And Payment
12.	Default
13.	Risks and Responsibilities
14.	Insurance
15.	Resolution of Disputes
16.	Integrity Pact

CONDITIONS OF CONTRACT

1. GENERAL PROVISIONS

1.1 Definitions

In the Contract as defined below, the words and expressions defined shall have the following meanings assigned to them, except where the context requires otherwise:

The Contract

- 1.1.1 ~~Contract~~ means the Contract Agreement and the other documents listed in the Contract Data.
- 1.1.2 ~~Specifications~~ means the document as listed in the Contract Data, including Procuring Agency's requirements in respect of design to be carried out by the Contractor (if any), and any Variation to such document.
- 1.1.3 ~~Drawings~~ means the Procuring Agency's drawings of the Works as listed in the Contract Data, and any Variation to such drawings.

Persons

- 1.1.4 ~~Procuring Agency~~ means the person named in the Contract Data and the legal successors in title to this person, but not (except with the consent of the Contractor) any assignee.
- 1.1.5 ~~Contractor~~ means the person named in the Contract Data and the legal successors in title to this person, but not (except with the consent of the Procuring Agency) any assignee.
- 1.1.6 ~~Party~~ means either the Procuring Agency or the Contractor.

Dates, Times and Periods

- 1.1.7 ~~Commencement Date~~ means the date fourteen (14) days after the date the Contract comes into effect or any other date named in the Contract Data.
- 1.1.8 ~~Day~~ means a calendar day
- 1.1.9 ~~Time for Completion~~ means the time for completing the Works as stated in the Contract Data (or as extended under Sub-Clause 7.3), calculated from the Commencement Date.

Money and Payments

- 1.1.10 ~~Cost~~ means all expenditure properly incurred (or to be incurred) by the Contractor, whether on or off the Site, including overheads and similar charges but does not include any allowance for profit.

Other Definitions

- 1.1.11 ~~Contractor's Equipment~~ means all machinery, apparatus and other things required for the execution of the Works but does not include Materials or Plant intended to form part of the Works.

- 1.1.12 ~~Country~~ means the Islamic Republic of Pakistan.
- 1.1.13 ~~Procuring Agency's Risks~~ means those matters listed in Sub-Clause 6.1.
- 1.1.14 ~~Force Majeure~~ means an event or circumstance which makes performance of a Party's obligations illegal or impracticable and which is beyond that Party's reasonable control.
- 1.1.15 Materials means things of all kinds (other than Plant) to be supplied and incorporated in the Works by the Contractor.
- 1.1.16 ~~Plant~~ means the machinery and apparatus intended to form or forming part of the Works.
- 1.1.17 ~~Site~~ means the places provided by the Procuring Agency where the Works are to be executed, and any other places specified in the Contract as forming part of the Site.
- 1.1.18 ~~Variation~~ means a change which is instructed by the Engineer/Procuring Agency under Sub-Clause 10.1.
- 1.1.19 Works means any or all the works whether Supply, Installation, Construction etc. and design (if any) to be performed by the Contractor including temporary works and any variation thereof.
- 1.1.20 ~~Engineer~~ means the person notified by the Procuring Agency to act as Engineer for the purpose of the Contract and named as such in Contract Data.

1.2 **Interpretation**

Words importing persons or parties shall include firms and organisations. Words importing singular or one gender shall include plural or the other gender where the context requires.

1.3 **Priority of Documents**

The documents forming the Contract are to be taken as mutually explanatory of one another. If an ambiguity or discrepancy is found in the documents, the priority of the documents shall be in accordance with the order as listed in the Contract Data.

1.4 **Law**

The law of the Contract is the relevant Law of Islamic Republic of Pakistan.

1.5 **Communications**

All Communications related to the Contract shall be in English language.

1.6 **Statutory Obligations**

The Contractor shall comply with the Laws of Islamic Republic of Pakistan and shall give all notices and pay all fees and other charges in respect of the

Works.

2. THE PROCURING AGENCY

2.1 Provision of Site

The Procuring Agency shall provide the Site and right of access thereto at the times stated in the Contract Data.

Site Investigation Reports are those that were included in the bidding documents and are factual and interpretative reports about the surface and subsurface conditions at the Site.

2.2 Obligations

2.2.1 The Procuring Agency shall, if requested by the Contractor, assist him in applying for permits, licenses or approvals which are required for the Works.

2.2.2 Assistance and Exemptions:

The procuring agency shall use its best efforts to ensure that the Government shall provide the contractor such assistance and exemptions.

2.2.3 Change in Applicable Law related to Taxes and Duties:

If, after the date of this contract, there is any change in the applicable law with respect to taxes and duties which increases or decrease the cost incurred by the contractor in performing the services, then the remuneration and reimbursable expenses otherwise payable to contractor under this contract shall be increased or decreased accordingly by agreement between the parties, and corresponding adjustments shall be made to the amounts.

2.3 Engineer's/Procuring Agency's Instructions

The Contractor shall comply with all instructions given by the Procuring Agency or the Engineer, if notified by the Procuring Agency, in respect of the Works including the suspension of all or part of the works.

2.4 Approvals

No approval or consent or absence of comment by the Engineer/Procuring Agency shall affect the Contractor's obligations.

3. ENGINEER'S/PROCURING AGENCY'S REPRESENTATIVES

3.1 Authorised Person

The Procuring Agency shall appoint a duly authorized person to act for him and on his behalf for the purposes of this Contract. Such authorized person shall be duly identified in the Contract Data or otherwise notified in writing to the Contractor as soon as he is so appointed. In either case the Procuring Agency shall notify the Contractor, in writing, the precise scope of the authority of such authorized person at the time of his appointment.

3.2 **Engineer's/Procuring Agency's Representative**

The name and address of Engineer's/Procuring Agency's Representative is given in Contract Data. However the Contractor shall be notified by the Engineer/Procuring Agency, the delegated duties and authority before the Commencement of works.

4. **THE CONTRACTOR**

4.1 **General Obligations**

The Contractor shall carry out the works properly and in accordance with the Contract. The Contractor shall provide all supervision, labour, Materials, Plant and Contractor's Equipment which may be required

4.2 **Contractor's Representative**

The Contractor shall appoint a representative at site on full time basis to supervise the execution of work and to receive instructions on behalf of the Contractor but only after obtaining the consent of the Procuring Agency for such appointment which consent shall not be withheld without plausible reason(s) by the Procuring Agency. Such authorized representative may be substituted/ replaced by the Contractor at any time during the Contract Period but only after obtaining the consent of the Procuring Agency as aforesaid.

4.3 **Subcontracting**

The Contractor shall not subcontract the whole of the works. The Contractor shall not subcontract any part of the works without the consent of the Procuring Agency.

4.4 **Performance Security**

The Contractor shall furnish to the Procuring Agency within fourteen (14) days after receipt of Letter of Acceptance a Performance Security at the option of the bidder, in the form of Payee's order /Bank Draft or Bank Guarantee from scheduled bank for the amount and validity specified in Contract Data.

5. **DESIGN BY CONTRACTOR**

5.1 **Contractor's Design**

The Contractor shall carry out design to the extent specified, as referred to in the Contract Data. The Contractor shall promptly submit to the Engineer/Procuring Agency all designs prepared by him, within fourteen (14) days of receipt the Engineer/Procuring Agency shall notify any comments or, if the design submitted is not in accordance with the Contract, shall reject it stating the reasons. The

Contractor shall not construct any element of the works designed by him within fourteen (14) days after the design has been submitted to the Engineer/Procuring Agency or which has been rejected. Design that has been rejected shall be promptly amended and resubmitted. The Contractor shall resubmit all designs commented on taking these comments into account

as necessary.

5.2 **Responsibility for Design**

The Contractor shall remain responsible for his bided design and the design under this Clause, both of which shall be fit for the intended purposes defined in the Contract and he shall also remain responsible for any infringement of any patent or copyright in respect of the same. The Engineer/Procuring Agency shall be responsible for the Specifications and Drawings.

6. **PROCURING AGENCY'S RISKS**

6.1 **The Procuring Agency's Risks**

The Procuring Agency's Risks are:-

- a) war, hostilities (whether war be declared or not), invasion, act of foreign enemies, within the Country;
- b) rebellion, terrorism, revolution, insurrection, military or usurped power, or civil war, within the Country;
- c) riot, commotion or disorder by persons other than the Contractor's personnel and other employees including the personnel and employees of Sub-Contractors, affecting the Site and/or the Works;
- d) ionising radiations, or contamination by radio-activity from any nuclear fuel, or from any nuclear waste from the combustion of nuclear fuel, radio-active toxic explosive, or other hazardous properties of any explosive nuclear assembly or nuclear component of such an assembly, except to the extent to which the Contractor/Sub-Contractors may be responsible for the use of any radio-active material;
- e) Pressure waves caused by aircraft or other aerial devices travelling at sonic or supersonic speeds;
- f) use or occupation by the Procuring Agency of any part of the Works, except as may be specified in the Contract;
- g) late handing over of sites, anomalies in drawings, late delivery of designs and drawings of any part of the Works by the Procuring Agency's personnel or by others for whom the Procuring Agency is responsible;
- h) a suspension under Sub-Clause 2.3 unless it is attributable to the Contractor's failure; and
- i) physical obstructions or physical conditions other than climatic conditions, encountered on the Site during the performance of the Works, for which the Contractor immediately notified to the Procuring Agency and accepted by the Procuring Agency.

7. TIME FOR COMPLETION

7.1 Execution of the Works

The Contractor shall commence the Works on the Commencement Date and shall proceed expeditiously and without delay and shall complete the Works, subject to Sub-Clause 7.3 below, within the Time for Completion.

7.2 Programme

Within the time stated in the Contract Data, the Contractor shall submit to the Engineer/Procuring Agency a programme for the Works in the form stated in the Contract Data.

7.3 Extension of Time

The Contractor shall, within such time as may be reasonable under the circumstances, notify the Procuring Agency/Engineer of any event(s) falling within the scope of Sub-Clause 6.1 or 10.3 of these Conditions of Contract and request the Procuring Agency/Engineer for a reasonable extension in the time for the completion of works. Subject to the aforesaid, the Procuring Agency/Engineer shall determine such reasonable extension in the time for the completion of works as may be justified in the light of the details/particulars supplied by the Contractor in connection with the such determination by the Procuring Agency/Engineer within such period as may be prescribed by the Procuring Agency/Engineer for the same; and the Procuring Agency may extend the time for completion as determined.

7.4 Late Completion

If the Contractor fails to complete the Works within the Time for Completion, the Contractor's only liability to the Procuring Agency for such failure shall be to pay the amount as **liquidity damages** stated in the Contract Data for each day for which he fails to complete the Works.

8. HANDING/TAKING-OVER

8.1 Handing Over

The Contractor at the moment of completed installation will hand over the number of units to Engineer/Procuring Agency.

8.2 Completion

The Contractor may notify the Engineer/Procuring Agency when he considers that the Works are complete.

8.3 Taking-Over Notice

Within ten (10) days of the receipt of the said notice of completion from the Contractor the Procuring Agency/Engineer shall either takeover the completed works and issue a Certificate of Completion to that effect or shall notify the Contractor his reasons for not taking-over the works. While issuing the Certificate of Completion as aforesaid, the Procuring Agency/Engineer may identify any outstanding items of work which the

Contractor shall undertake during the Maintenance Period.

9. REMEDYING DEFECTS

9.1 Remedying Defects

The Contractor shall for a period stated in the Contract Data from the date of issue of the Certificate of Completion carry out, at no cost to the Procuring Agency, repair and rectification work which is necessitated by the earlier execution of poor quality of work or use of below specifications material in the execution of Works and which is so identified by the Procuring Agency/Engineer in writing within the said period. Upon expiry of the said period, and subject to the Contractor's faithfully performing his aforesaid obligations, the Procuring Agency/Engineer shall issue a Maintenance Certificate whereupon all obligations of the Contractor under this Contract shall come to an end.

Failure to remedy any such defects or complete outstanding work within a reasonable time shall entitle the Procuring Agency to carry out all necessary works at the Contractor's cost. However, the cost of remedying defects not attributable to the Contractor shall be valued as a Variation.

9.2 Uncovering and Testing

The Engineer/Procuring Agency may give instruction as to the uncovering and/or testing of any work. Unless as a result of an uncovering and/or testing it is established that the Contractor's design, materials, plant or workmanship are not in accordance with the Contract, the Contractor shall be paid for such uncovering and/or testing as a Variation in accordance with Sub-Clause 10.2.

10. VARIATIONS AND CLAIMS

10.1 Right to Vary

The Procuring Agency/Engineer may issue Variation Order(s) in writing. Where for any reason it has not been possible for the Procuring Agency/Engineer to issue such Variations Order(s), the Contractor may confirm any verbal orders given by the Procuring Agency/Engineer in writing and if the same are not refuted/denied by the Procuring Agency/Engineer within ten (10) days of the receipt of such confirmation the same shall be deemed to be a Variation Orders for the purposes of this Sub-Clause.

10.2 Valuation of Variations

Variations shall be valued as follows:

- a) at a lump sum price agreed between the Parties, or
- b) where appropriate, at rates in the Contract, or
- c) in the absence of appropriate rates, the rates in the Contract shall be used as the basis for valuation, or failing which

- d) at appropriate new rates, as may be agreed or which the Engineer/Procuring Agency considers appropriate, or
- e) if the Engineer/Procuring Agency so instructs, at day work rates set out in the Contract Data for which the Contractor shall keep records of hours of labour and Contractor's Equipment, and of Materials, used.

10.3 Changes in the Quantities.

- a) If the final quantity of the work done differs from the quantity in the Bill of Quantities for the particular item by more than 25 percent, provided the change exceeds 1 percent of the Initial Contract Price, the Procuring Agency/Engineer shall adjust the rate to allow for the change and will be valued as per sub clause 10.2.
- b) The Engineer shall not adjust rates from changes in quantities if thereby the Initial Contract Price is exceeded by more than 15 percent, except with the prior approval of the Procuring Agency.
- c) If requested by the Engineer, the contractor shall provide the Engineer with a detailed cost breakdown of any rate in the Bill of Quantities.

10.4 Early Warning

The Contractor shall notify the Engineer/Procuring Agency in writing as soon as he is aware of any circumstance which may delay or disrupt the Works, or which may give rise to a claim for additional payment.

To the extent of the Contractor's failure to notify, which results to the Engineer/Procuring Agency being unable to keep all relevant records or not taking steps to minimize any delay, disruption, or Cost, or the value of any Variation, the Contractor's entitlement to extension of the Time for Completion or additional payment shall be reduced/rejected.

10.5 Valuation of Claims

If the Contractor incurs Cost as a result of any of the Procuring Agency's Risks, the Contractor shall be entitled to the amount of such Cost. If as a result of any Procuring Agency's Risk, it is necessary to change the Works, this shall be dealt with as a Variation subject to Contractor's notification for intention of claim to the Engineer/Procuring Agency within fourteen (14) days of the occurrence of cause.

10.6 Variation and Claim Procedure

The Contractor shall submit to the Engineer/Procuring Agency an itemized detailed breakdown of the value of variations and claims within twenty eight (28) days of the instruction or of the event giving rise to the claim. The Engineer/Procuring Agency shall check and if possible agree the value. In the absence of agreement, the Procuring Agency shall determine the value.

11. CONTRACT PRICE AND PAYMENT

11.1 (a) **Terms of Payments**

As per special stipulation Schedule C to bid

Provided that the Interim Payment shall be caused in thirty (30) days and Final Payment in 60 days in case of foreign funded project. In the event of the failure of the Procuring Agency to make payment within 90 days then Procuring Agency shall pay to the Contractor compensation at the 28 days rate of KIBOR+2% per annum in local currency and LIBOR+1% for foreign currency, upon all sums unpaid from the date by which the same should have been paid.

(b) **Valuation of the Works**

The Works shall be valued as provided for in the Contract Data, subject to Clause 10.

11.2 **Monthly Statements**

11.3 **Interim Payments**

Within a period not exceeding seven (07) days from the date of submission of a statement for interim payment by the Contractor, the Engineer shall verify the same and within a period not exceeding fifteen (15) days from the said date of submission by the Contractor, the Procuring Agency shall pay to the Contractor the sum subject to adjustment for deduction of the advance payments and retention money.

11.4 **Retention**

Retention money shall be paid by the Procuring Agency to the Contractor within fourteen (14) days after either the expiry of the period stated in the Contract Data, or the remedying of notified defects, or the completion of outstanding work, all as referred to in Sub-Clause 9.1, whichever is the later.

11.5 **Final Payment**

Within ten (10) working days from the date of issuance of the Maintenance Certificate the Contractor shall submit a final account to the Engineer to verify and the Engineer shall verify the same within fourteen (14) days from the date of submission and forward the same to the Procuring Agency together with any documentation reasonably required to enable the Procuring Agency to ascertain the final contract value.

Within thirty (30) days from the date of receipt of the verified final account from the Engineer, the Procuring Agency shall pay to the Contractor any amount due to the Contractor. While making such payment the Procuring Agency may, for reasons to be given to the Contractor in writing, withhold any part or parts of the verified amount.

11.6 **Currency**

Payment shall be in the currency stated in the Contract Data.

12. DEFAULT

12.1 Defaults by Contractor

If the Contractor abandons the Works, refuses or fails to comply with a valid instruction of the Engineer/Procuring Agency or fails to proceed expeditiously and without delay, or is, despite a written complaint, in breach of the Contract, the Procuring Agency may give notice referring to this Sub-Clause and stating the default.

If the Contractor has not taken all practicable steps to remedy the default within fourteen (14) days after receipt of the Procuring Agency's notice, the Procuring Agency may by a second notice given within a further twenty one (21) days, terminate the Contract. The Contractor shall then demobilize from the Site leaving behind any Contractor's Equipment which the Procuring Agency instructs, in the second notice, to be used for the completion of the Works at the risk and cost of the Contractor.

12.2 Insolvency

If a Party is declared insolvent under any applicable law, the other Party may by notice terminate the Contract immediately. The Contractor shall then demobilise from the site leaving behind, in the case of the Contractor's insolvency, any Contractor's Equipment which the Procuring Agency instructs in the notice is to be used for the completion of the Works.

13. RISKS AND RESPONSIBILITIES

13.1 Contractor's Care of the Works

Subject to Sub-Clause 9.1, the Contractor shall take full responsibility for the care of the Works from the Commencement Date until the date of the Procuring Agency's/Engineer's issuance of Certificate of Completion under Sub-Clause 8.2. Responsibility shall then pass to the Procuring Agency. If any loss or damage happens to the Works during the above period, the Contractor shall rectify such loss or damage so that the Works conform with the Contract.

Unless the loss or damage happens as a result of any of the Procuring Agency's Risks, the Contractor shall indemnify the Procuring Agency, or his agents against all claims loss, damage and expense arising out of the Works.

13.2 Force Majeure

If Force Majeure occurs, the Contractor shall notify the Engineer/Procuring Agency immediately. If necessary, the Contractor may suspend the execution of the Works and, to the extent agreed with the Procuring Agency demobilize the Contractor's Equipment.

If the event continues for a period of eighty four (84) days, either Party may then give notice of termination which shall take effect twenty eight (28) days after the giving of the notice.

After termination, the Contractor shall be entitled to payment of the unpaid balance of the value of the Works executed and of the Materials and Plant reasonably delivered to the Site, adjusted by the following:

- a) any sums to which the Contractor is entitled under Sub-Clause 10.4.
- b) the cost of his demobilization, and
- c) less any sums to which the Procuring Agency is entitled.

The net balance due shall be paid or repaid within thirty five (35) days of the notice of termination.

14. INSURANCE

14.1 Arrangements

The Contractor shall, prior to commencing the Works, effect insurances of the types, in the amounts and naming as insured the persons stipulated in the Contract Data except for items (a) to (e) and (i) of the Procuring Agency's Risks under Sub-Clause 6.1. The policies shall be issued by insurers and in terms approved by the Procuring Agency. The Contractor shall provide the Engineer/Procuring Agency with evidence that any required policy is in force and that the premiums have been paid.

14.2 Default

If the Contractor fails to effect or keep in force any of the insurances referred to in the previous Sub-Clause, or fails to provide satisfactory evidence, policies or receipts, the Procuring Agency may, without prejudice to any other right or remedy, effect insurance for the cover relevant to such as a default and pay the premiums due and recover the same plus a sum in percentage given in Contractor Data from any other amounts due to the Contractor.

15. RESOLUTION OF DISPUTES

15.1 Engineer's Decision

If a dispute of any kind whatsoever arises between the Procuring Agency and the Contractor in connection with the works, the matter in dispute shall, in the first place, be referred in writing to the Engineer, with a copy to the other party. Such reference shall state that it is made pursuant to this Clause. No later than the twenty eight (28) days after the day on which he received such reference, the Engineer shall give notice of his decision to the Procuring Agency (Superintending Engineer) and the Contractor.

Unless the Contract has already been repudiated or terminated, the Contractor shall, in every case, continue to proceed with the work with all due diligence, and the Contractor and the Procuring Agency (Superintending Engineer) shall give effect forthwith to every such decision of the Engineer unless and until the same shall be revised, as hereinafter provided in an arbitral award.

15.2 **Notice of Dissatisfaction**

If a Party is dissatisfied with the decision of the Engineer of consultant or if no decision is given within the time set out in Sub-Clause 15.1 here above, the Party may give notice of dissatisfaction referring to this Sub-Clause within fourteen (14) days of receipt of the decision or the expiry of the time for the decision. If no notice of dissatisfaction is given within the specified time, the decision shall be final and binding on the Parties. If notice of dissatisfaction is given within the specified time, the decision shall be binding on the Parties who shall give effect to it without delay unless and until the decision of the Engineer is revised by an arbitrator.

If a contractor is dissatisfied with the decision of the Engineer of the department or decision is not given in time then he can approach Superintending Engineer within 14 days, in case of dissatisfaction with decision of Superintending Engineer or not decided within 28 days, then arbitration process would be adopted as per clause 15.3.

15.3 **Arbitration**

A dispute which has been the subject of a notice of dissatisfaction shall be finally settled as per provisions of Arbitration Act 1940 (Act No. X of 1940) and Rules made there under and any statutory modifications thereto. Any hearing shall be held at the place specified in the Contract Data and in the language referred to in Sub-Clause 1.5.

16 **INTEGRITY PACT**

16.1 If the Contractor or any of his Sub-Contractors, agents or servants is found to have violated or involved in violation of the Integrity Pact signed by the Contractor as Schedule-F to his Bid, then the Procuring Agency shall be entitled to:

- (a) recover from the Contractor an amount equivalent to ten times the sum of any commission, gratification, bribe, finder's fee or kickback given by the Contractor or any of his Sub-Contractors, agents or servants;
- (b) terminate the Contract; and
- (c) recover from the Contractor any loss or damage to the Procuring Agency as a result of such termination or of any other corrupt business practices of the Contractor or any of his Sub-Contractors, agents or servants.

On termination of the Contract under Sub-Para (b) of this Sub-Clause, the Contractor shall demobilize from the site leaving behind Contractor's Equipment which the Procuring Agency instructs, in the termination notice, to be used for the completion of the works at the risk and cost of the Contractor. Payment upon such termination shall be made under Sub-Clause 12.4, in accordance with Sub-Para (c) thereof, after having deducted the amounts due to the Procuring Agency under Sub-Para (a) and (c) of this Sub-Clause.

TABLE OF CONTENTS

PART II - SPECIAL/PARTICULAR CONDITIONS OF CONTRACT

Clause	Title	Page
1.1	Definitions	145
3.1	Engineer's Duties and Authority	
4.3	Contractor's Representative	145
6.10	Records of Contractor's Personnel and equipment	145
7.9	Use of Pakistani Materials and Services	145
8.1	Commencement of Works	145
8.11	Prolonged Suspension	
8.3	Programme	
13.1	Right to vary	
13.3	Variation procedure	
13.8	Adjustment for changes in cost	
14.1	Contract Price	
14.2	Advance Payment	
14.5	Plants and Materials intended for Works	
14.8	Delayed Payments	
15.2	Termination by Employer/Procuring Agency	
15.6	Corrupt and fraudulent Practices (Integrity Pact).	
16.4	Payment on Termination	
17.3	Employer's/Procuring Agency's Risks	
18.1	General Requirements for Insurance	
19.6	Optional Termination, Payment and release by the Employer	
20.1	Contractor's Claims	
20.2	Appointment of the Dispute Board / Notification of the Committee	
20.3	Failure to agree on the composition of the Dispute Board.	
20.4	Obtaining Dispute Board's Decision	
20.5	Amicable Settlement.	
20.6	Arbitration	
20.7	Failure to comply with Dispute Board's Decision	
20.8	Expiry of Dispute Board's Appointment	
APPE		
NDIX.	General Conditions of Dispute Board Agreement	
Annex	PROCEDURAL RULES	

PART II - SPECIAL /PARTICULAR CONDITIONS OF CONTRACT

1.1 Definitions

1.1.1.4 "Form of Bid" is synonymous with "Letter of Tender".

1.1.1.5 "Bid" is synonymous with "Tender".

1.1.1.10 "Bidding" is synonymous with "contract".

The following paragraph is added:

1.1.1.11 "Programme" means the programme to be submitted by the contractor in accordance with

Sub-Clause 8.3 and any approved revisions thereto.

1.1.2.2 "Employer" is synonymous with "Procuring

Agency" 1.1.2.9 "DB" is synonymous with "Committee".

1.1.3.1 Replace 28 days by 7 days in LCB and 15 days in ICB..

1.1.3.7 "Defects notification Period" is synonymous with "Defects liability Period".

1.15 Inspections and Audit by the Bank

Deleted

Procuring Agency can retain this clause with or without changes, in case of contracts under Project, Bank and donor's programme.

3.1 Engineer's Duties and Authority.

The following paragraph is added after duties:

Procuring agency shall ensure that the Engineer's Representative/Staff is a professional engineer as defined in the Pakistan Engineering Council Act 1975 (V of 1976)

4.3 Contractor's Representative

The following text is to be added after last line:

The contractor's authorised representative and his other professional engineers working at site shall register themselves with the Pakistan Engineering Council.

6.10 Records of Contractor's Personnel and Equipment

The following paragraph is added:

The Contractor shall, upon request by the Engineer at any time in relation to any item

of hired Contractor's Equipment, forthwith notify the Engineer in writing the name and address of the Owner of the equipment and shall certify that the agreement for the hire thereof contains a provision in accordance with the requirements set forth above.

The following sub-clause 7.9 is added in (GCC):

7.9 Use of Pakistani Materials and Services

The contractor shall, so far as may be consistent with the contract, make the maximum use of materials, supplies, plant and equipment indigenous to or produced or fabricated in Pakistan and services, available in Pakistan provided such materials, supplies, plant, equipment and services shall be of required standard.

8.1 Commencement of Works

The last para is deleted and substituted with the following:

The contractor shall commence the works on site within the period named in Appendix-A to Bid from the date of receipt by him from the Engineer of a written Notice to Commence. Thereafter, the contractor shall proceed with the works with due expedition and without delay.

- 8.11 Prolonged Suspension
Replace 84 days by 120 days.

8.3 Programme

The following text is to be added after [Commencement of Works]
The programme shall be submitted in the either form of:

- a) Bar Chart identifying the critical activities.
- b) Critical Path Method (CPM) identifying the critical path/activities.
- c) Program Evaluation and Review Techniques (PERT).
(Procuring Agency to select appropriate one)

13.1 Right to vary

In the last line of Para, after the word "Variation", the word "in writing" is added.

13.3 Variation procedure

In the tenth line, after the words "as soon as practicable" following is added: "and within a period not exceeding one-eighth of the completion time"

- 14.1 The Contract
Price Sub-para (d)
is deleted.

14.2 Advance Payment

Advance Payment/Mobilization Advance shall be made available to the Contractor by the procuring agency on following conditions:

Mobilization Advance/Advance Payment

- (i) Mobilization advance up to 10 % of the Contract Price may be paid by the procuring agency to the Contractor on the works costing Rs2.5 million or above on following conditions:
 - a. on submission by the Contractor of a mobilization advance guarantee

for the full amount of the advance in the specified form, from a Scheduled Bank in Pakistan, acceptable to the procuring agency:

- b. contractor shall pay interest on the mobilization advance at the rate of 10% per annum on the advance: and
 - (ii) This Advance including the interest shall be recovered in 5 equal installments from the 5 R.A bills and in case the number of bills is less than 5 then 1/5 of the advance inclusive of the interest thereon shall be recovered from each bill and the balance together with interest be recovered from the final bill. It may be insured that there is sufficient amount in the final bill to enable recovery of the Mobilization Advance.

14.5 Plants and Materials intended for Works

Add the following paragraph as sub-clause 14.5 (d) for Secured Advance on non-perishable materials and sub-clauses (a), (b) and (c) will be applicable for plants only :-

- (I) The Contractor shall be entitled to receive from the procuring agency Secured Advance against an INDENTURE BOND in Public Works Account Form No.31 (Fin. R. Form No. 2) acceptable to the procuring agency of such sum as the Engineer may consider proper in respect of non-perishable materials brought at the site but not yet incorporated in the Permanent Works provided that:
 - (i) The materials are in accordance with the specifications for the permanent works;
 - (ii) Such materials have been delivered to the site and are properly stored and protected against loss or damage or deterioration to the satisfaction and verification of the Engineer/Assistant Engineer but at the risk and cost of the Contractor;
 - (iii) The Contractor's records of the requirements, orders, receipts and use of materials are kept in a form approved by the Engineer, and such records shall be available for inspection by the Engineer;
 - (iv) The Contractor shall submit with his monthly statement the estimated value of the materials on site together with such documents as may be required by the Engineer for the purpose of valuation of materials and providing evidence of ownership and payment therefore;
 - (v) Ownership of such materials shall be deemed to vest in the procuring agency and these materials shall not be removed from the site or otherwise disposed of without written permission of the procuring agency;
 - (vi) The sum payable for such materials on site shall not exceed 75 % of the (i) landed cost of imported materials, or (ii) ex-factory / ex-warehouse price of locally manufactured or produced materials, or (iii) market price of stands other materials;
 - (vii) Secured Advance shall not be allowed unless and until the previous advance, if any, is fully recovered;
 - (viii) Detailed account of advances must be kept in part II of running account bill or a separate statement: and
 - (ix) Secured Advance may be permitted only against materials/quantities anticipated to be consumed / utilized on the work within a period of 3 months from the date of issue of secured advance and in no case for full quantities of materials for the entire work/contract.

(II) Recovery of Secured Advance:

Secured Advance paid on non-perishable materials to the Contractor under the above provisions shall be effected from the monthly payments on actual consumption basis, but not later than period specified in the rules not more than three months (even if unutilized);

14.8 Delayed Payment

Second Para is replaced with following text:

In the event of the failure of the Procuring Agency to make the payment within the time stated, the procuring agency shall pay to the contractor in case of **ICB contracts only**, the compensation at rate of KIBOR+2% per annum in local currency and Libor+1% for foreign currency, upon all sums to be paid from the date of which the same would have been paid.

15.2 Termination by Employer

The following Para is added at the end of the sub-clause:

Provided further, that in addition to the action taken by the procuring agency against the Contractor under this Clause, the procuring agency may also refer the case of default of the Contractor to Pakistan Engineering Council for punitive action under the Construction and Operation of Engineering Works Bye-Laws 1987, as amended from time to time.

15.6 Corrupt and fraudulent Practices.

The following text is to be added as 3rd paragraph:

Successful Contractor has to provide Integrity Pact (for contracts worth

Rs.10.0 million and above).

If the Contractor or any of his Subcontractors, agents or servants is found to have violated or involved in violation of the Integrity Pact signed by the Contractor as Appendix-L to his Bid, then the procuring agency shall be entitled to:

- (a) recover from the Contractor an amount equivalent to ten times the sum of any commission, gratification, bribe, finder's fee or kickback given by the Contractor or any of his Subcontractors, agents or servants;
- (b) terminate the Contract; and
- (c) recover from the Contractor any loss or damage to the procuring agency as a result of such termination or of any other corrupt business practices of the Contractor or any of his Subcontractors, agents or servants.

The termination under sub-para (b) of this Sub-Clause shall proceed in the manner prescribed under sub-clauses 15.2 & 15.5 and the payment under Sub-Clause 15.4 shall be made after having deducted the amounts due to the procuring agency under Sub-Para (a) and (c) of this Sub-Clause.

16.4 Payment on Termination

Sub-paragraph (c) is deleted.

17.3 Employer's/ Procuring Agency's Risks

Sub-Clause 17.3 (h) is deleted.

The following text is added in Clause 18.1 (GCC):

18.1 General Requirements for Insurance

The contractor shall be obliged to place all insurances relating to the contract (including, but not limited to, the insurances referred to in Clauses 18.1,18.2,18.3,18.4) with Insurance Company having at least AA rating from PACRA/JCR in favour of the Employer//Procuring Agency valid for a period 28 days after beyond the Bid Validity date.

Costs of such insurances shall be borne by the contractor.

19.6 Optional Termination, Payment and release by the Employer

Sub-clauses (c), (d) and (e) are deleted.

20.6 Arbitration

Text will be replaced as under:

Any dispute in respect of which:

(a) *the decision, of the Dispute Board has not become final and binding pursuant to sub-clause 20.2, and*

(b) *amicable settlement has not been reached within the period stated in sub-clause 20.5, shall be finally settled, under the provisions of the Arbitration Act, 1940 as amended or any statutory modification/Rules of Conciliation And Arbitration PEC Islamabad or re-enactment thereof for the time being in force.*

The place of arbitration shall be in Sindh Province.

Procuring Agency can retain this clause without changes, in case of contracts under Project, Bank and donor's programme except the place of arbitration shall be in Sindh

Province.

Annex PROCEDURAL RULES

Procuring Agency can retain these rules with or without changes, in case of contracts under Project, Bank and donor's programme.

PART II –SPECIAL/PARTICULAR CONDITIONS OF CONTRACT

INDEX	CLAUSE
Adjustment for changes in cost	13.8
	14.2
Amicable Settlement.	20.5
Appointment of the Dispute Board / Notification of the Committee	20.2
Arbitration	20.6
Commencement of Works	8.1
Contractor's Representative	4.3
Contractor's Claims	20.1
Contract Price	14.1
Corrupt and fraudulent Practices (Integrity Pact).	15.6
Definitions	1.1
Delayed Payments	14.8
Employer's/Procuring Agency's Risks	17.3
Engineer's Duties and Authority	3.1
Expiry of Dispute Board's Appointment	20.8
Failure to agree on the composition of the Dispute Board.	20.3
Failure to comply with Dispute Board's Decision	20.7
General Conditions of Dispute Board Agreement	Appendix
General Requirements for Insurance	18.1
Optional Termination, Payment and release by the Employer	19.6
Obtaining Dispute Board's Decision	20.4
Payment on Termination	15.6
Plants and Materials intended for Works	14.5
PROCEDURAL RULES	Annex
Prolonged Suspension	8.11
Programme	8.3
Records of Contractor's Personnel and equipment	6.10
Right to vary	13.1
Termination by Employer/Procuring Agency	15.2
Use of Pakistani Materials and Services	7.9
Variation procedure	13.3

**OVERVIEW
&
SPECIFICATIONS**

DRAWINGS

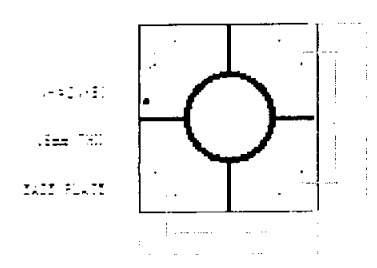
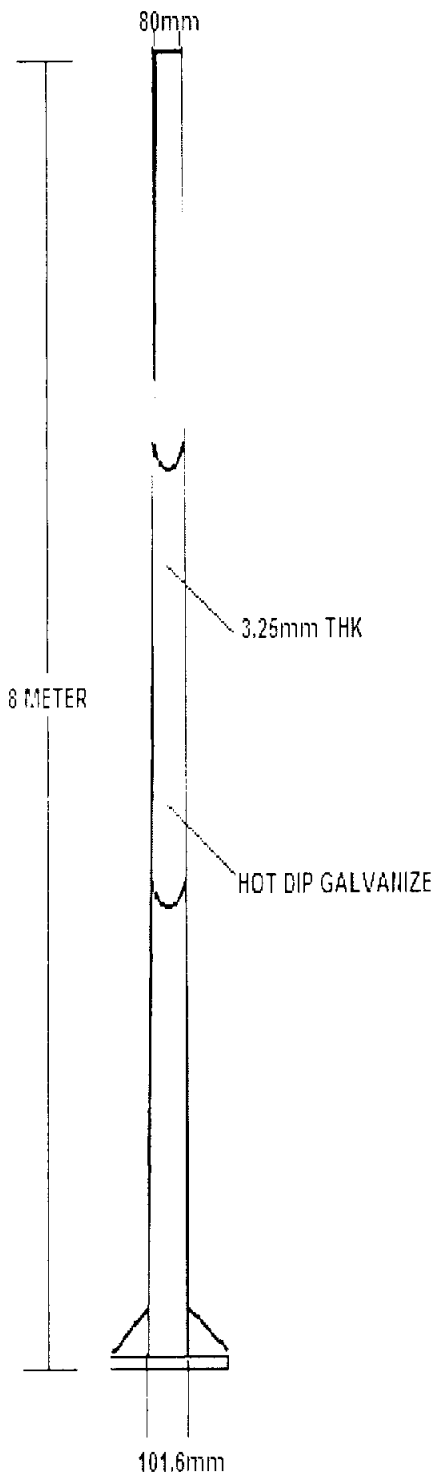

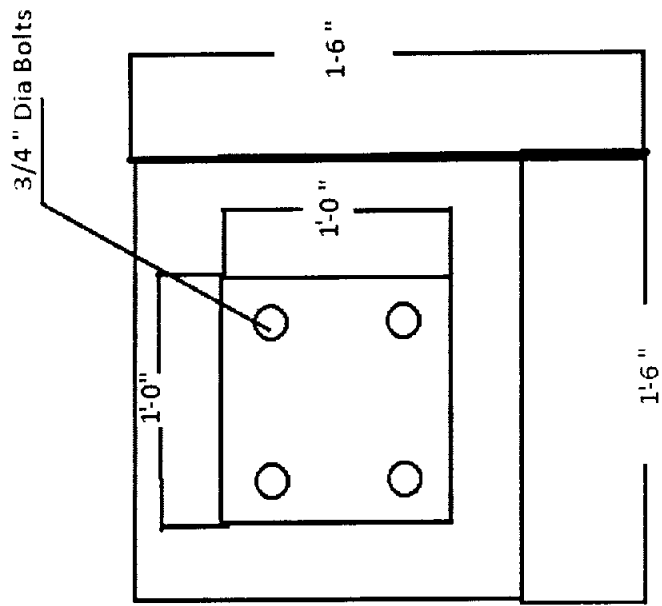
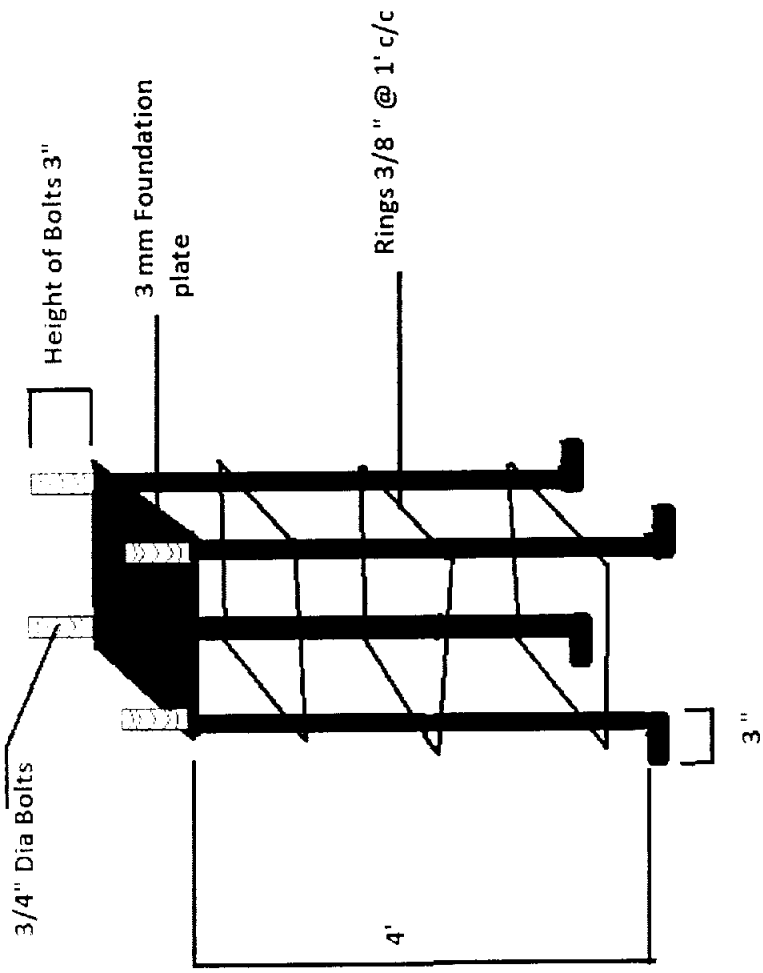



GOVERNMENT OF SINDH
LOCAL GOVERNMENT, RURAL DEVELOPMENT,
PHE & HTP DEPARTMENT
(RD WING)

Karachi dated the 16th September, 2015

NOTIFICATION

NO. SO(A)/RDD/Misc:277/2015: In supersession of this department Notification No. SO(A)/RDD/Committee(Tender)/2011/265 dated 8th January, 2015, a procurement committee comprising the following officers is hereby re-constituted to keep the tendering process transparent and as per strategy in Rural Development Department with immediate effect till further order:-

- | | |
|---|----------|
| 1. Director (Technical), concerned. | Convener |
| 2. Executive Engineer RDD concerned. | Member |
| 3. MR. Shoukat Ali Memon, Assistant Engineer
PHED, Tando Muhammad Khan | Member |

SECRETARY
To GOVERNMENT OF SINDH

NO. SO(A)/RDD/Misc:277/2015:

Karachi dated the 16th September, 2015

A copy is forwarded for information and necessary action to:-

1. The Director General, Rural Development Department, Sindh, Hyderabad w/r to his letter No.-DG/RDD/(Procurement Committee)/2014-15/324 dated 22-07-2015.
2. The Director (Dev) Rural Development Department _____ (AMB)
3. The Executive Engineer, Rural Development Department _____ (AM)
4. P.S. to Secretary, Local Government, Rural Development, PHE & HTP Department, Karachi.
5. P.S. to Special Secretary, Local Government, Rural Development, PHE & HTP Department (RD Wing), Karachi.
6. Officers Concerned.
7. Notification File.

SECTION OFFICER (ADMN)
For SECRETARY TO GOVT. OF SINDH



GOVERNMENT OF SINDH
PUBLIC HEALTH ENGINEERING & RURAL
DEVELOPMENT DEPARTMENT
(RD WING)

(Karachi, dated) January 2016

CORRIGENDUM

No. SO(A)RDD/MISC/277/2015 In suppression of this Department's Notification of even number dated 17 January 2016, composition of constituted Redressal Committee [Sindh Public Procurement Rule-31 Section (1), (2)] shall be as under:

- | | |
|--|-----------------|
| 1. Director General, Rural Development Department (Sindh), Hyderabad | (Convener) |
| 2. Mr. Ghulam Sarwar Soomro, D.O. (Tech.) | (Member) |
| 3. Divisional Accounts Officer Representative of AG Sindh | (Member) |
| 4. Mr. Akhtar Ahmed Almani Eng. PHED Hyderabad | (Member) |
| 5. Section Officer (Tech.) | (Member - Secy) |

SECRETARY
TO GOVERNMENT OF SINDH

No. SO(A)RDD/MISC/277/2015

(Karachi dated) January 2016

A copy is forwarded for information and necessary action to:

1. The Director General, RDD, Sindh, Hyderabad, w.r to his letter No. DG RDD (Redressal Committee) 2015/38 dated 16/9/2015
2. The Director (Tech.) RDD, Sindh, Hyderabad.
3. The Director (Dev.) RDD, Sindh, Hyderabad (All)
4. The Assistant Director (Dev.) RDD, Sindh, Hyderabad (All)
5. The Executive Engineer, RDD, Sindh, Hyderabad (All)
6. The District Accounts Officer, concerned.
7. Divisional Accounts Officer Representative of AG Sindh
8. PS to Additional Chief Secretary (Dev.) P&D Department, Karachi
9. PS to Secretary, PH & RD Department, G.S, Karachi
10. PA to Addl. Secretary, RD Department, G.S, Karachi
11. Notification file

SECTION OFFICER (Tech.)
RURAL DEVELOPMENT DEPARTMENT

**PROVINCIAL
PUBLIC HEALTH ENGG., RURAL DEVELOPMENT & HOUSING TOWN PLANNING DEPARTMENT**

Gen. Sr. No.	Sector / Sub-sector / Name of Scheme	Location of Scheme/ District	Status Date of Approval	Target Date for Completion	Estimated Cost	Actual Expenditure upto June, 15	Revised Allocation 2015-16		Estimated Expenditure upto June' 16	Throw forward as on 01-07-16	Allocation for 2016-17		Financial Progress in %age upto		Financial Projection		
							Total	F.P.A.			Capital	Revenue	Jun'16	Jun'17	2017-18	2018-19	
							8	9			12	13	14	15	16	17	18
2056	Sewerage Scheme at village Hot Khan Jalbani (Mubalha Abmed Khan Jalbani, Nek Muhammad Jalbani, Ghulam Sarwar (Late) & Haji Latif Jalbani, Taluka Mehrabpur	N.Feroze	Un-Approved	June-18	10.000	0.000	0.000	0.000	0.000	10.000	2.500	0.000	0.000	0	25	3.750	3.750
2057	Rural Drainage in Village Shahal Khan Bijarani, Taluka Tangwani	Kashmore	Un-Approved	June-18	10.000	0.000	0.000	0.000	10.000	2.500	0.000	0.000	0.000	0	25	3.750	3.750
	Total Sanitation (New Schemes) Initiatives to achieve SDGs :-				121.000	0.000	0.000	0.000	121.000	30.750	0.000	0.000	0.000	0	25	45.125	45.125
	Total Sanitation (OG+New):-				161.000	0.000	0.000	10.000	151.000	60.750	0.000	0.000	0.000	0	25	45.125	45.125
Housing and Community Amenities																	
<u>(New scheme)</u>																	
<u>Initiatives to Achieve Sustainable Development Goal # 7 (SDGs)</u>																	
2058	Installation of Solar Lights in Rural Sindh.	Sindh	Un-Approved	June-19	3200.000	0.000	0.000	0.000	3200.000	0.000	800.000	0.000	0.000	0	25	1200.000	1200.000
2059	Electrification of Off Grid Areas through Solar Technology, Schools & Villages (Rev: Rs. 2000.00 million).	Sindh	Un-Approved	June-18	2000.000	0.000	0.000	0.000	2000.000	0.000	500.000	0.000	0.000	0	25	1500.00	0.000
	Total Housing & Community Amenities (New Scheme)				5200.000	0.000	0.000	0.000	5200.000	0.000	1300.000	0.000	0.000	0	25	2700.000	1200.000
	Total Rural Dev: (Ongoing schemes):-				1597.002	0.000	287.356	287.356	1309.646	1309.646	0.000	1309.646	0.000	0.000	0.000	0.000	0.000
	Initiatives to achieve SDGs:-				6746.900	0.000	0.000	0.000	6746.900	390.354	1300.000	1690.354	0.000	0.000	0.000	3278.273	1778.273
	Total Rural Development:-				8343.902	0.000	287.356	287.356	8056.546	1700.000	3000.000	3000.000	0.000	0.000	0.000	3278.273	1778.273
	Total PHE & RD (On-going)				25465.582	5854.209	3175.433	0.000	9276.892	16188.690	4410.088	0.000	4410.088	0.000	0.000	6034.189	5744.413
	Total PHE & RD (New) Initiatives to achieve SDGs:-				9894.046	0.000	0.000	0.000	9894.046	1181.912	1300.000	2481.912	0.000	0.000	0.000	4463.576	2948.558
	Total PHE & RD (New) except SDGs:-				1500.000	0.000	0.000	0.000	1500.000	375.000	0.000	0.000	0.000	0.000	0.000	562.500	562.500
	Total PHE & RD (New) :-				11394.046	0.000	0.000	0.000	11394.046	1556.912	1300.000	2856.912	0.000	0.000	0.000	5026.076	3511.058
	TOTAL PHE & RD :-				36859.628	5854.209	3175.433	0.000	9276.892	27582.736	5967.000	1300.000	7267.000	0.000	0.000	9255.471	9255.471